

## Relay C

2PH from 60A to 210A

Rev. 01/2019

PMA-C2-60-210A



A publication of:



**PMA**  
**Prozeß- und Maschinen-Automation GmbH**  
**P.O.Box 310 229 • D-34058 Kassel • Germany**

All rights reserved.

No part of this document may be reproduced or published in any form or by any means without prior written permission from the copyright owner.

### **Liability and warranty**

Any information and notes in these operating instructions were composed under consideration of the applicable regulations, the present state of the art and our extensive know-how and experience. With special versions, additional ordering options or due to the latest technical modifications, the actual scope of delivery may vary from the descriptions and drawings in this manual. For questions, please, contact the manufacturer.



Before starting to work with the instrument and before commissioning, in particular, these operating instructions must be read carefully! The manufacturer cannot be held responsible for damage and trouble resulting from failure to comply with the information given in this manual.

This product may be subject to change due to improvements of the product features in the course of further development.

### **Copyright**

This operating manual should be considered as confidential information, intended only for persons who work with the instrument.

Contraventions are subject to payment of damages. Further claims reserved.

<b>Contents</b>	
<b>1. Important Warnings for Safety</b>	<b>5</b>
<b>2. Maintenance</b>	<b>7</b>
<b>3. Introduction</b>	<b>8</b>
<b>3.1 Advantages compared with analog thyristor unit</b>	<b>8</b>
<b>3.2 Overview</b>	<b>9</b>
<b>4. Software Configurator</b>	<b>10</b>
<b>5. Quick Start</b>	<b>11</b>
<b>6. Basic Connections and Sizing</b>	<b>12</b>
<b>7. Identification</b>	<b>13</b>
<b>7.1 Identification of the unit</b>	<b>13</b>
<b>8. Order Code</b>	<b>14</b>
<b>8.1 Notes on the options:</b>	<b>15</b>
8.1.1 Heaterbreak alarm (HB)	15
8.1.2 Datalogger	15
8.1.3 Energy totalizer	15
<b>9. Technical Specifications</b>	<b>16</b>
<b>9.1 General features</b>	<b>16</b>
<b>9.2 Input features</b>	<b>16</b>
<b>9.3 Output features (power device)</b>	<b>16</b>
<b>9.4 Fan specification (only from 90 to 210A)</b>	<b>16</b>
<b>9.5 Environmental installation conditions</b>	<b>17</b>
<b>9.6 Derating curve</b>	<b>17</b>
<b>9.7 Calculating flow capacity of the fan</b>	<b>17</b>
<b>10. Installation</b>	<b>18</b>
<b>10.1 Dimensions and weight</b>	<b>19</b>
<b>10.2 Fixing holes</b>	<b>19</b>
<b>11. Wiring Instructions</b>	<b>20</b>
<b>11.1 Terminal positions</b>	<b>20</b>
<b>11.2 Power terminals</b>	<b>20</b>
<b>11.3 Control terminals</b>	<b>21</b>
11.3.1 Terminal block M1	21
11.3.2 Terminal block M2	21
11.3.3 Terminal block M3	21
<b>11.4 Schematic</b>	<b>22</b>
11.4.1 SSR control input schematic	23
<b>11.5 Connection Diagram for 3 phases (control on 2 phases)</b>	<b>24</b>
<b>12. Control Panel</b>	<b>25</b>
<b>12.1 Menu navigation</b>	<b>26</b>
<b>12.2 Control Panel Led</b>	<b>27</b>
<b>12.3 Displayed alarms</b>	<b>27</b>
<b>12.4 Parameter list</b>	<b>28</b>
12.4.1 Operator Menu	28
12.4.2 Setup Menu	29
12.4.3 Advanced Setup Menu	29
12.4.4 Hardware Menu	31
12.4.5 Communication Menu	34
12.4.6 Monitoring Menu	35
<b>13. Using the Configurator</b>	<b>38</b>
<b>13.1 Typical Uses</b>	<b>38</b>
<b>13.2 Communicating with Power Controllers</b>	<b>38</b>
<b>13.3 Recipes</b>	<b>38</b>
13.3.1 Upload a recipe	38
13.3.2 Download a recipe	38
<b>13.4 How To</b>	<b>38</b>
13.4.1 Install and communication with the power controller	38
<b>13.5 Using the Configurator</b>	<b>39</b>
13.5.1 To view or save a power controller's settings using "Simple" view section:	39
13.5.2 To edit a setting in a recipe:	40
13.5.3 To download a recipe file into a power controller:	40
13.5.4 To monitor a power controller with the Test view:	40
13.5.5 To log in on the test view to change the digital input and analog input functions:	40
13.5.6 To log out the test view:	40
13.5.7 To view data on the scope:	41







13.5.8 To reset the power totals: .....	41
13.5.9 Setting up and using data logging.....	41
13.5.10 To retrieve a data log file from the power controller: .....	42
<b>13.6 Software general information.....</b>	<b>42</b>
13.6.1 Program window .....	42
13.6.2 Simple section .....	42
13.6.3 Test section .....	43
13.6.4 Load analyzer .....	45
13.6.5 Data log window .....	46
13.6.6 Data log configuration window .....	46
13.6.7 MSG view .....	47
13.6.8 Settings window .....	47
<b>14. Firing Type .....</b>	<b>48</b>
<b>14.1 Zero crossing.....</b>	<b>48</b>
<b>14.2 Burst firing.....</b>	<b>48</b>
<b>15. Control Mode (feed-back) .....</b>	<b>49</b>
<b>16. Supply the Electronic Board .....</b>	<b>50</b>
<b>17. RS485 Serial port.....</b>	<b>51</b>
<b>18. Fieldbus Communication Option .....</b>	<b>51</b>
<b>19. Internal Fuse .....</b>	<b>52</b>
<b>19.1 Fuses replacement.....</b>	<b>53</b>

# 1. Important Warnings for Safety

This chapter contains important information for the safety. The not observance of these instructions may result in serious personal injury or death and can cause serious damages to the Thyristor unit and to the components system included.

The installation should be performed by qualified persons.

In the manual are used symbols to give more evidence at the notes of safety and operativity for the attention for the user:

	This icon is present in all the operational procedures where the Improper operation may result in serious personal injury or death by Electrical Shock Hazard Symbol (a lightning bolt in a triangle) precedes an electric shock hazard CAUTION or WARNING safety statement.
	Warning or Hazard that needs further explanation than the label on unit can provide. Consult User's Guide for further information.
	Unit is compliant with European Union directives. See Declaration of Conformity for further details on Directives and Standards used for Compliance.
	If available, unit is a Listed device per Underwriters Laboratories. It has been investigated to ANSI/UL® 508 standards for Industrial Control Switches and equivalent to CSA C22.2 #14. For more detail search for File E505847 on <a href="http://www.ul.com">www.ul.com</a>
	ESD Sensitive product, use proper grounding and handling techniques when installing or servicing product.
	Do not throw in trash, use proper recycling techniques or consult manufacturer for proper disposal.

A “NOTE” marks a short message to alert you to an important detail.

A “CAUTION” safety alert appears with information that is important for protecting your equipment and performance. Be especially careful to read and follow all cautions that apply to your application.

A “WARNING” safety alert appears with information that is important for protecting you, others and equipment from damage. Pay very close attention to all warnings that apply to your application.

## 1.1 Safety notes













 **WARNING!** To avoid damage to property and equipment, injury and loss of life, adhere to applicable electrical codes and standard wiring practices when installing and operating this product. Failure to do so could result in damage, injury and death.

 **WARNING!** All service including inspection, installation, wiring, maintenance, troubleshooting, fuse or other user serviceable component replacement must be performed only by properly qualified personnel. Service personnel must read this manual before proceeding with work. While service is being performed unqualified personnel should not work on the unit or be allowed in the immediate vicinity.

 **WARNING!** When in use the power controller is connected to dangerous voltages. Do not remove the protective covers without first disconnecting and preventing power from being restored while servicing the unit.

 **WARNING!** Do not use in aerospace or nuclear applications.

 **WARNING!** The power controller's protection rating is IP20 with all covers installed and closed. It must be installed in an enclosure that provides all the necessary additional protections appropriate for the environment and application.

-  **WARNING!** Ground the power controller via the provided protective earth grounding terminal. Verify ground is within impedance specifications. This should be verified periodically.
-  **WARNING!** Electric Shock Hazard: when the power controller has been energized, after shutting off the power, wait at least one minute for internal capacitors to discharge before commencing work that brings you in to contact with power connections or internal components.
-  **WARNING!** The installation must be protected by electromagnetic circuit breakers or by fuses. The semiconductor fuses located inside the power controller are classified for UL as supplementary protection for semiconductor devices. They are not approved for branch circuit protection.
-  **WARNING!** When making live voltage or current measurements, use proper personal protective equipment for the voltages and arc-flash potentials involved.
-  **WARNING!** Verify the voltage and current ratings of the power controller are correct for the application.
-  **CAUTION:** To avoid compromising the insulation, do not bend wire or other components beyond their bend radius specifications.
-  **CAUTION:** Protect the power controller from high temperature, humidity and vibrations.
-  **CAUTION:** The power controller warranty is void if the tested and approved fuses are not used.
-  **CAUTION:** Only trained and authorized personnel should access and handle the internal electronics and they must follow proper electro-static prevention procedures.
-  **CAUTION:** Install an appropriately sized RC filter across contactor coils, relays and other inductive loads.
-  **NOTE!** Provide a local disconnect to isolate the power controller for servicing.
-  **NOTE!** The nominal current is specified for ambient temperatures at or below 40° C. Ensure the application design allows for adequate cooling of each power controller. The power controller must be mounted vertically. The cooling design must prevent air heated by one power controller from causing power controllers mounted above to exceed the ambient operating temperature limit. When power controllers are mounted side by side allow a minimum spacing of 15mm between them.
-  **NOTE!** Use only copper cables and wires rated for use at 75°C or greater.

## 2. Maintenance

In order to have a corrected cooling, the user must clean the heat-sink and the protective grill of the fans. The frequency of this servicing depends on environmental pollution.

Also check periodically if the screw for the power cables and safety earth are tightened correctly (See Connection Diagram).

### 3. Introduction

A thyristor unit is semiconductor device which acts as a switch formed by two thyristors in antiparallel. To switch on the alternating current the input signal will be on and the thyristor will switch off at first Zero Crossing voltage with no input signal. The benefits of thyristor units compared with electromechanical contactors are numerous: no moving parts, no maintenance and capacity to switch very fast. Thyristors are the only solution to control transformers and special loads that change resistance with temperature and with age.

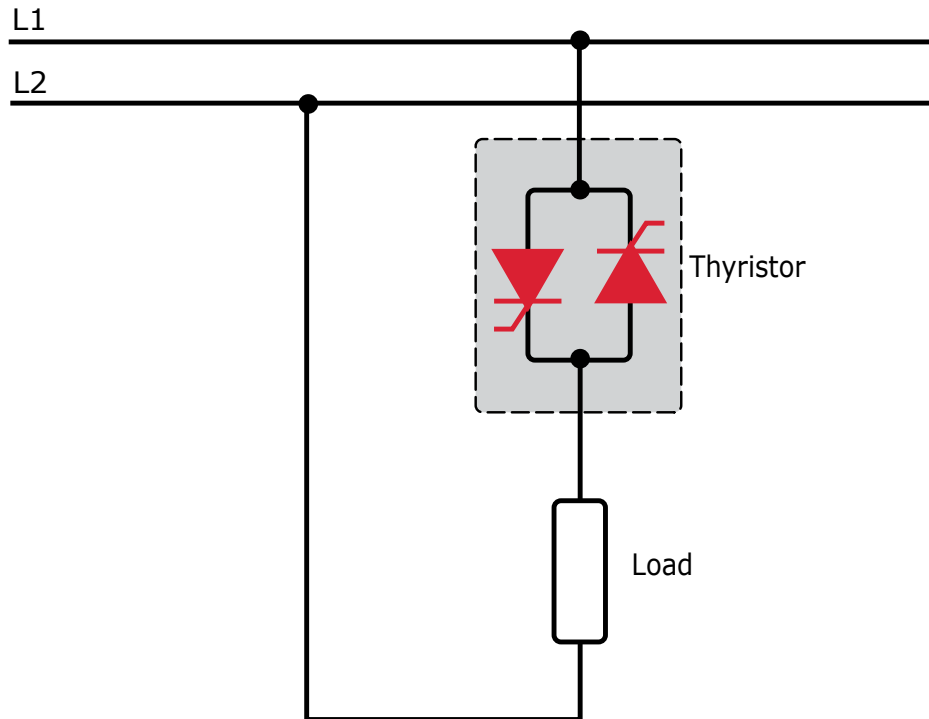

#### 3.1 Advantages compared with analog thyristor unit

Communication RS485 is a standard feature of Relay C. This allows the use of many information like: current, power, load state and all the parameters for diagnostic and configuration. Ulterior advantages of the digital system vs the analogical is the flexibility and the possibility of implement special characteristics without change the hardware. Several strategies can be implemented and selected through the configuration parameters. With the software Thyristor Configurator, you can have access to the configuration parameters. To connect the Thyristor unit to the computer use a micro USB cable.





## 3.2 Overview

### Integrated semiconductor fusing, current transformer and user interface

- Saves installation time and eases setup and commissioning
- Delivers a user-friendly, intuitive interface

### Industry-leading design and serviceability

- Offers a robust SCR design to meet a rugged industrial environment's high quality and reliability needs
- Provides quick and easy access to maintain and service fuses and individual legs in minimal time
- Enables fast troubleshooting by providing helpful thermal system diagnostics

### Comprehensive power controller range

- Provides wide range of options from simple single phase to complex three-phase loads to 690V.

### 100KA short circuit current rating (SCCR) (Not reviewed by UL®)

- Enables greater protection in the event of a short circuit

### c-UL® 508 listed

- Shortens project schedules, agency testing and expenses

### Control modes: contactor, voltage, current or power

- Satisfies a wide range of demanding thermal applications

### Load firing modes: zero-cross, burst fire

- Handles a wide range of load types including nichrome, medium and long waveform infrared lamps, moly, transformers, silicon carbide, UV lamps and tungsten
- Protects and extends the life of connected loads

### Wide range of communication protocols

- Enable factory and process automation with connectivity to process and equipment data via Modbus® RTU, Modbus® TCP, Profibus, Profinet, USB device (configuration and data file transfers)

### Open heater and shorted SCR indication

- Minimizes production downtime with easy to understand, intelligent, troubleshooting diagnostics

### Integrated USB and user interface for configuration

- Easily and safely program configuration settings as the user interface can be powered through USB connection
- Eliminates need to work in a high voltage hazard environment. High voltage to the power controller and system panel can be shut off and locked out for safety while configuring controller.

## 4. Software Configurator

Thyristor configurator software is free and is possible download it from our site.

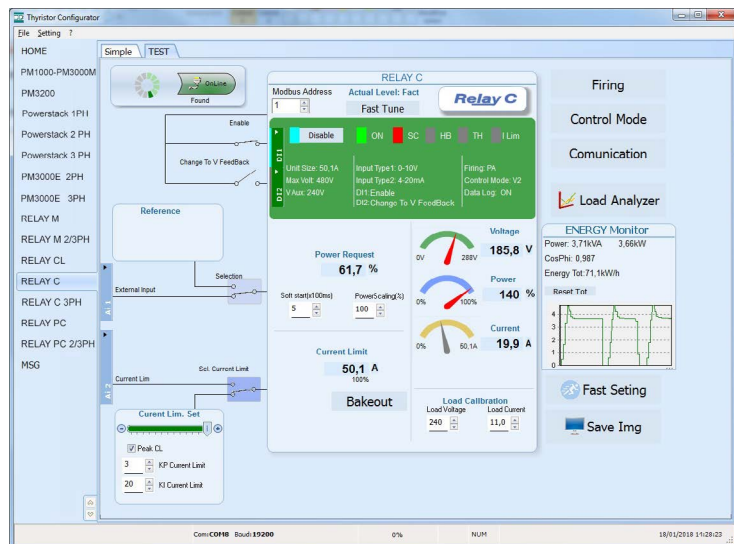

If the Order Code is in line with requirement, then unit has been already configured in Factory and it's ready to use.

You need the software only to modify the ordered configuration. Anyway, we suggest to check the unit on the machine with the "Test unit" section.

For install the software, launch the program and follow the instructions on the screen. Run the software configurator and set the correct serial port number by menu setting -> Serial Port -> port number.

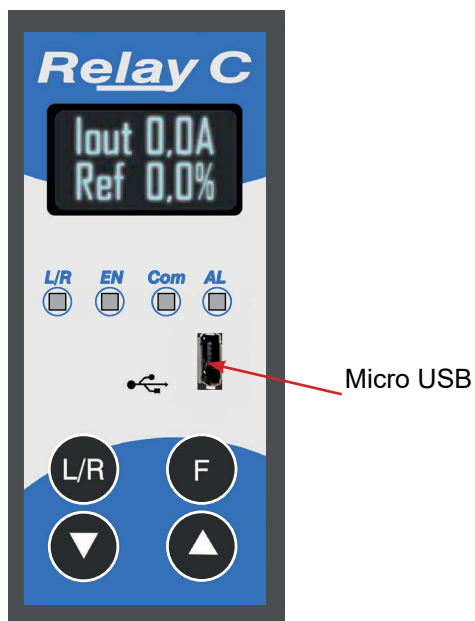

To connect the unit at the PC, it's necessary to use the micro USB 2.0 Modbus RTU cable. USB connection need a driver to work properly, you can find it from our site.

However the configuration software installer will install as default the correct driver.

## 5. Quick Start



**Attention: this procedure must be carried out by skilled people only.**

If your Relay C code is in line with what you really need, then the main configuration is already done by Producer and you just need to do the following steps:

### 1. Verify Relay C current sizing. Be sure that:

- the load current is equal or less than the nominal one of Relay C
- the main voltage is equal or less than the nominal voltage of Relay C

### 2. Verify the Installation

### 3. Verify the Wiring:

- all auxiliary connections must be done in line with wirings on this manual
- verify that there isn't a short circuit on the load

### 4. Supply the auxiliary voltage of the unit in the Set menu

Set the parameters Operative Load Voltage and Nominal Current of the load using the frontal keypad or Thyristor configurator software.

**The auxiliary voltage supply of the Relay C unit must be synchronized with load voltage power supply.**

If the Auxiliary Voltage (written on the identification label) is different from Supply Voltage (to the load), use an external transformer.

**If your Relay C code is NOT in line with what you really need, use the configurator software tool to set-up the unit. Install the software on your PC, select Relay C and click on test unit changing what you need.**

## 6. Basic Connections and Sizing

Star wiring with resistive load (control on two phases with PMA-Relay C-2PH)

$$I = \frac{P}{1,73V}$$

V = Nominal voltage of the load

I = Nominal current of the load

P = Nominal power of the load

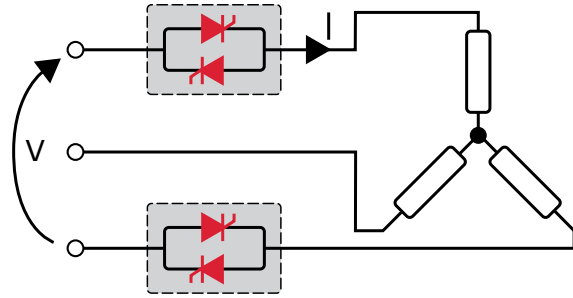

Delta wiring with resistive load (control on two phases with PMA-Relay C-2PH)

$$I = \frac{P}{1,73V}$$

V = Nominal voltage of the load

I = Nominal current of the load

P = Nominal power of the load

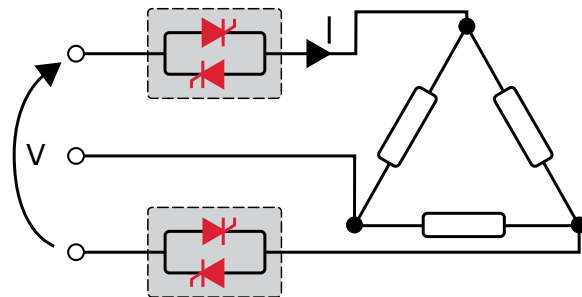

## 7. Identification

### 7.1 Identification of the unit



**Caution: Before to install, make sure that the Thyristor unit have not damages. If the product has a fault, please contact the dealer from which you purchased the product.**

The identification's label gives all the information regarding the factory settings of the Thyristor unit, this label is on the unit, like represented in figure.

Verify that the product is the same thing as ordered.

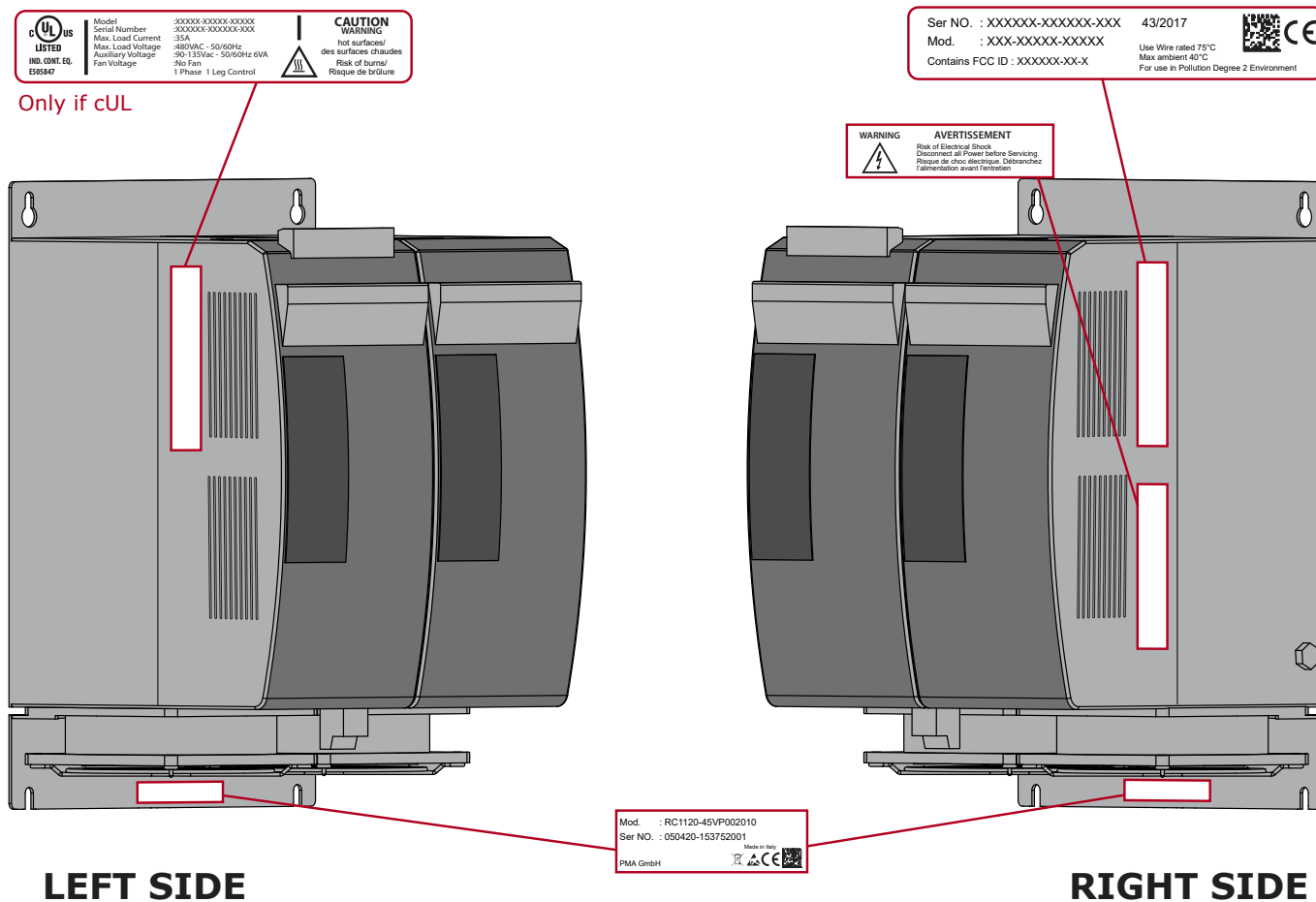

## 8. Order Code

RC2		x	x	x	-	x	x	x	x	x	x	x	x	x	x	x	x
<b>Current - Fuses</b>		↓	↓	↓													
60 A - Fixed Fuses Included		0	6	0													
90 A - Fixed Fuses Included		0	9	0													
120 A - Fixed Fuses Included		1	2	0													
150 A - Fixed Fuses Included		1	5	0													
180 A - Fixed Fuses Included		1	8	0													
210 A - Fixed Fuses Included		2	1	0													
<b>MAX VOLTAGE</b>					↓												
480 V					4												
600 V					6												
690 V					7												
<b>MAIN SUPPLY VOLTAGE 1*</b>		<b>Aux Voltage range</b>			↓												
100/120 Vac		90 to 135 Vac			1												
200/208/230/240 Vac		180 to 265 Vac			2												
277 Vac		238 to 330 Vac			3												
380/415/480 Vac		342 to 528 Vac			5												
600 Vac		540 to 759 Vac			6												
690 Vac		540 to 759 Vac			7												
<b>INPUT</b>						↓											
SSR							S										
0:20 mA							B										
4:20 mA							A										
0:10 V (DC)							V										
10 kΩ potentiometer							K										
<b>FIRING</b>		<b>START OPTION</b>					↓										
Burst Firing (BF)		No soft start					B										
Zero Crossing		No soft start					Z										
<b>CONTROL MODE</b>								↓									
Open Loop								O									
Voltage								U									
Voltage Square U <sup>2</sup>								Q									
Current								I									
Current Square I <sup>2</sup>								A									
Power (U x I)								W									
<b>OPTION</b>									↓								
No Option									0								
Energy totalizer									1								
Datalogger									2								
Datalogger + Energy totalizer									3								
Heaterbreak Alarm (HB)									8								
Heaterbreak Alarm (HB) + Energy totalizer									9								
Heaterbreak Alarm (HB) + Datalogger									A								
Heaterbreak Alarm (HB) + Datalogger + Energy totalizer									B								
<b>FAN VOLTAGE</b>									↓								
No fan < 90A									0								
Fan 110Vac (≥ 120A)									1								
Fan 230Vac (≥ 120A) – standard version									2								
24Vdc (≥ 120A) - standard version									3								
<b>APPROVALS</b>										↓							
CE										0							
cULus + CE										L							

LOAD TYPE		
Normal Resistive Load with 3 Phase Star without neutral Connection		0
Normal Resistive Load with 3 Phase Delta Connection		1
IRSW Infrared Short wave with 3 Phase Star Connection		2
IRSW Infrared Short wave with 3 Phase Delta Connection		3
COMMUNICATION AND RETRANSMISSION		
No.1 Modbus RTU	No Retransmission	0
	Retransmission 4:20 mA	1
	Retransmission 0:10 V	2
No.2 Modbus RTU	No Retransmission	3
	Retransmission 4:20 mA	4
	Retransmission 0:10 V	5
No.2 Profibus DP + No. 1 Modbus RTU	No Retransmission	6
	Retransmission 4:20 mA	7
	Retransmission 0:10 V	8
No.2 Profinet + No. 1 Modbus RTU	No Retransmission	9
	Retransmission 4:20 mA	A
	Retransmission 0:10 V	B
No.2 Modbus TCB + No. 1 Modbus RTU	No Retransmission	C
	Retransmission 4:20 mA	D
	Retransmission 0:10 V	E

\*1 Since the supply voltage of the electronics is used for synchronization, it must be in phase with the load voltage.

## 8.1 Notes on the options:

### 8.1.1 Heaterbreak alarm (HB)

HB Alarm for partial or total load failure and Short Circuit on SCR (relay output).

### 8.1.2 Datalogger

This feature is important to see the historical data of parameter like Current, Voltage and Power and can be useful to diagnose a fault.

### 8.1.3 Energy totalizer

This function totalizes the energy consumption of the load allowing the calculation of heat treatment.

## 9. Technical Specifications

### 9.1 General features

Cover and Socket material	PolymericV2
Utilization Category	AC-51 AC-55b
IP Code	20
Method of Connecting	Load in Delta, Load in Star
Auxiliary voltage	Order Code RC2____-1 = line voltage 100/120V voltage range 90:135V (8 VA Max) Order Code RC2____-2 = line voltage 200/208/220/230/240V voltage range 180:265V (8 VA Max) Order Code RC2____-3 = line voltage 277 voltage range 238:330V (8 VA Max) Order Code RC2____-5 = line voltage 380/400/415/440/480V voltage range 342:528V (8 VA Max) Order Code RC2____-6 = line voltage 600V voltage range 540:759V (8 VA Max) Order Code RC2____-7 = line voltage 690V voltage range 540:759V (8 VA Max)
Relay output for Heater Break Alarm (only with HB option)	0.5A a 125VAC

### 9.2 Input features

Analog Input V:	0 to 10 VDC impedance 15 k $\Omega$
Analog Input I:	4 to 20 mA Impedance 100 $\Omega$
Potentiometer	10 k $\Omega$ min.
Digital Input	4 to 30Vdc 5mA Max (ON $\geq$ 4Vdc OFF < 1Vdc)

### 9.3 Output features (power device)

Current (A)	Nominal Voltage range (Ue) (V)	Repetitive peak reverse voltage (Uimp)		Latching current (mAeff)	Max peak one cycle (10 msec.) (A)	Leakage current (mAeff)	FUSE I2T value Suggested A2s (at500V) tp= 10msec	Frequency range (Hz)	Power loss Thyristor + Fuse I =Inom (W)	Isolation Voltage (Ui) (A)
		(480V)	(600V)							
60	24÷600	1200	1600	600	1900	15	10780	47÷70	205	3000
90	24÷600	1200	1600	600	1900	15	10780	47÷70	290	3000
120	24÷600	1200	1600	600	1900	15	14280	47÷70	398	3000
150	24÷600	1200	1600	300	5000	15	17500	47÷70	409	3000
180	24÷600	1200	1600	300	5000	15	30800	47÷70	486	3000
210	24÷600	1200	1600	300	5000	15	53900	47÷70	598	3000

### 9.4 Fan specification (only from 90 to 210A)

Supply: 230V Standard Power 32W (16W for 2 Fan)

Supply: 115V Option Power 28W (14W for 2 Fan)



### 9.5 Environmental installation conditions

Ambient temperature	0-40°C (32-104°F) at nominal current. Over 40°C-104°F use the derating curve.
Storage temperature	-25°C to 70°C -13°F to 158°F
Installation place	Don't install at direct sun light, where there are conductive dust, corrosive gas, vibration or water and also in salty environmental.
Altitude	Up to 1000 meter over sea level. For higher altitude reduce the nominal current of 2% for each 100m over 1000m
Humidity From	5 to 95% without condense and ice
Pollution Level	Up to 2nd Level ref. IEC 60947-1 6.1.3.2

### 9.6 Derating curve

$$I_{max} = I_{nominal} \times K$$

● Derating

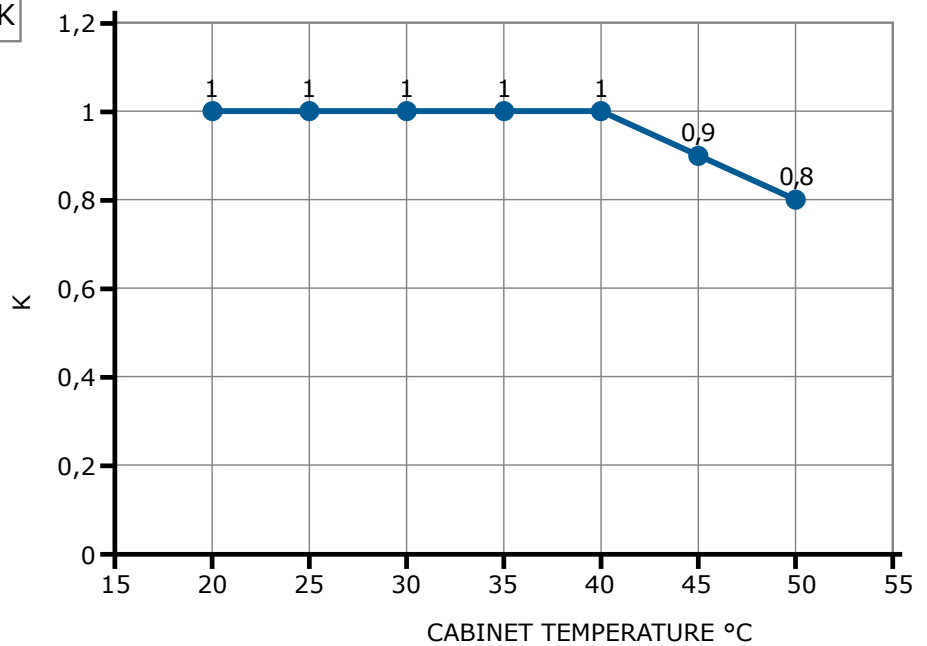

For higher cabinet temperature contact the producer of the unit

### 9.7 Calculating flow capacity of the fan

All the thyristor units when are in conduction produces power loss that is dissipated inside cubicle in terms of heating. Due to this fact the internal temperature of cubicle is higher than ambient temperature. To be cooled the thyristor need of fresh air cooling and to do it is normally used a fan mounted on the front door or on the roof of the cabinet.

Procedure to size **Fan air mass flow (V)**: see power loss for each thyristor and fuse mounted indicated in the manual related to the current (Output feature and Internal fuse Chapter).

$V = f \cdot \frac{Q_v}{t_c - t_a}$	<b>Q<sub>v</sub></b> = total power losses (w) (thyristor + fuse power loss)	<b>Altitude</b> 0:100 meters f = 3.1 m³K/Wh 100:250 meters f = 3.2 m³K/Wh 250:500 meters f = 3.3 m³K/Wh 500:750 meters f = 3.4 m³K/Wh
	<b>t<sub>a</sub></b> = ambient temperature (°C) <b>t<sub>c</sub></b> = cabinet temperature (°C) <b>V</b> = fan air mass flow (m³/h) <b>f</b> = altitude coefficient (see table on right)	



The formulas used are for information only and is not a substitute for a proper thermal rating done by a qualified person.

## 10. Installation

Before to install, make sure that the Thyristor unit have not damages. If the product has a fault, please contact the dealer from which you purchased the product. Verify that the product is the same thing as ordered.

The Thyristor unit must be always mounted in vertical position to improve air cooling on heat-sink.

**Maintain the minimum distances (\*) in vertical and in Horizontal as represented, this area must be free from obstacle (wire, copper bar, plastic channel).**

When more unit has mounted inside the cabinet maintain the air circulation like represented in figure without obstacle for the air flow. Is necessary to install a fan to have better air circulation as calculated previously.

**The V Air flow must be equal or more than the value calculated. If the cabinet fan mounted by the customer have an air flow lower than the correct value the warranty will decay.**

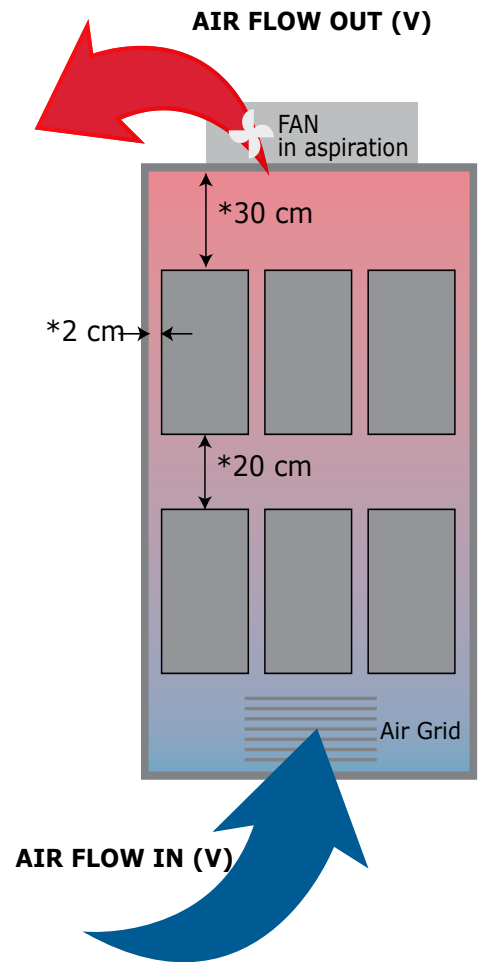

## 10.1 Dimensions and weight

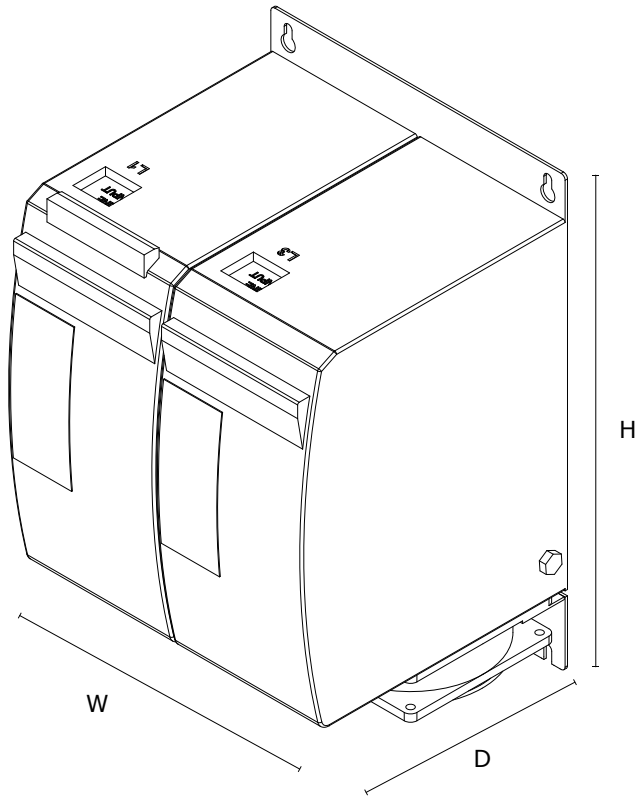

Type	W	H	D	Weight
2PH 60A no Fan (SR13)	186 mm	269 mm	170 mm	6.8 kg
2PH 90-210A with Fan (SR16)	186 mm	273 mm	170 mm	7.0 kg

## 10.2 Fixing holes

H1:  
 2PH (60A no Fan): 256  
 2PH (90-210A with Fan): 260

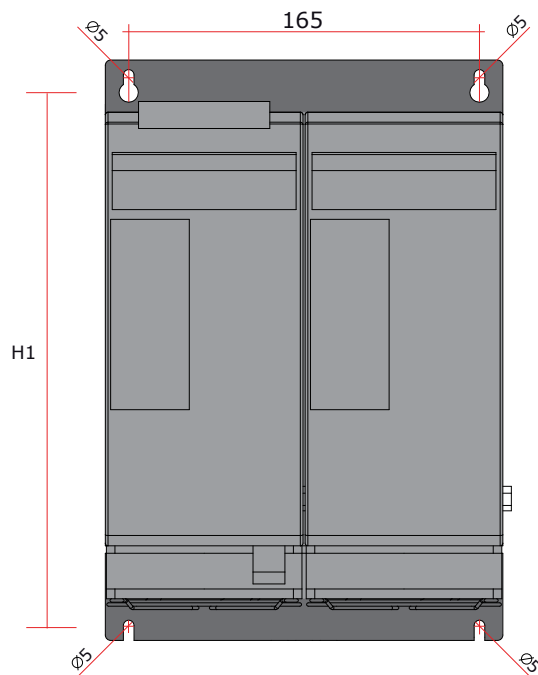

# 11. Wiring Instructions

The Thyristor unit could be susceptible to interferences lost by near equipments or by the power supply, for this reason in accord to the fundamental practices rules is opportune take some precautions:

- The coil contactor, the relays and other inductive loads must be equipped with opportune RC filter.
- Use shielded bipolar cables for all the input and output signals.
- The signal cables must not be near and parallel to the power cables.
- Local regulations regarding electrical installation should be rigidly observed.

Use 75°C copper (CU) conductor only, wire ranges (AWG), wire terminal type (ZMVV), terminal tightening torque in the table below.

## Power cable torque (suggested)

Type	Connector Type	Torque Lb-in (N-m)	Wire Range mm <sup>2</sup> (AWG)	MAX Current Terminals	Wire Terminals UL Listed (ZMVV)
060 090 120	Screw M6	70.8 (8.0)	16(5) 25(3) 35(2)	150	Fork/Spade Terminal Copper Tube Crimp. Lug
150 180 210	Screw M8	141,6 (16.0)	50(0) 70(00) 90(000)	250	Fork/Spade Terminal Copper Tube Crimp. Lug

Cable dimensions of the Command Terminals 0.5 mm<sup>2</sup> (AWG 18)

Cable dimensions of the Earth (suggested) 16 mm<sup>2</sup> (AWG 6) up to 120A  
25 mm<sup>2</sup> (AWG 4) up to 210A

## 11.1 Terminal Positions

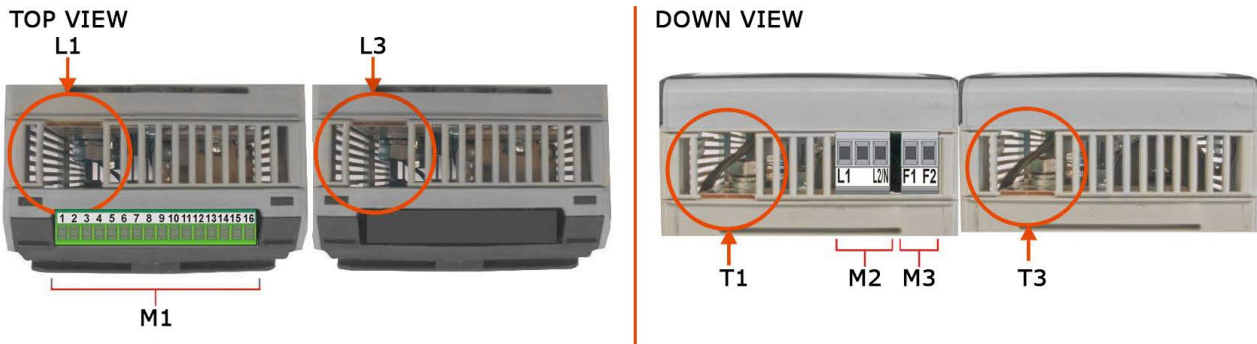

**Warning:** Before connecting or disconnecting the unit check that power and control cables are isolated from voltage sources.

## 11.2 Power terminals

Terminal	Description
L1	Line Input Phase 1
T1	Load Output Phase 1
L3	Line Input Phase 3
T3	Load Output Phase 3

## 11.3 Control Terminals



**Warning:** Before connecting or disconnecting the unit check that power and control cables are isolated from voltage sources.

### 11.3.1 Terminal block M1

Terminal	Description
1	0V 0V GND
2	COM I - Common Digital Input
3	DI 2 – Enable Digital Input
4	DI 1 - Configurable Input
5	+ Analog Input1 (0-10Vdc/4-20mA Analog Setpoint)
6	- Analog Input1 (0-10Vdc/4-20mA Analog Setpoint)
7	Output +10Vdc stabilized 1 mA MAX
8	+ Analog Input2 (0-10Vdc/4-20mA Reference/ext.feed-back)
9	Slave Output
10	Retransmission Output
11	RS485 A
12	RS485 B
13	0V GND
14	C - Common contact alarm relay output
15	NC - Normally Close contact alarm relay output (Thermal or SC/HB/CL)
16	NO - Normally Open contact alarm relay output (Thermal or SC/HB/CL)

### 11.3.2 Terminal block M2

Terminal	Description
L1	Aux – Voltage Supply for electronic boards and synchronization (See order code for the Value)
-	Not Connected
L2/N	Aux – Voltage Supply for electronic boards and synchronization (See order code for the Value)

### 11.3.3 Terminal block M3

Terminal	Description
F1	Fan supply (230V Standard – 115 Option - for DC Fan Option +24Vdc)
F2	Fan supply (230V Standard – 115 Option - for DC Fan Option -24Vdc)

## 11.4 Schematic

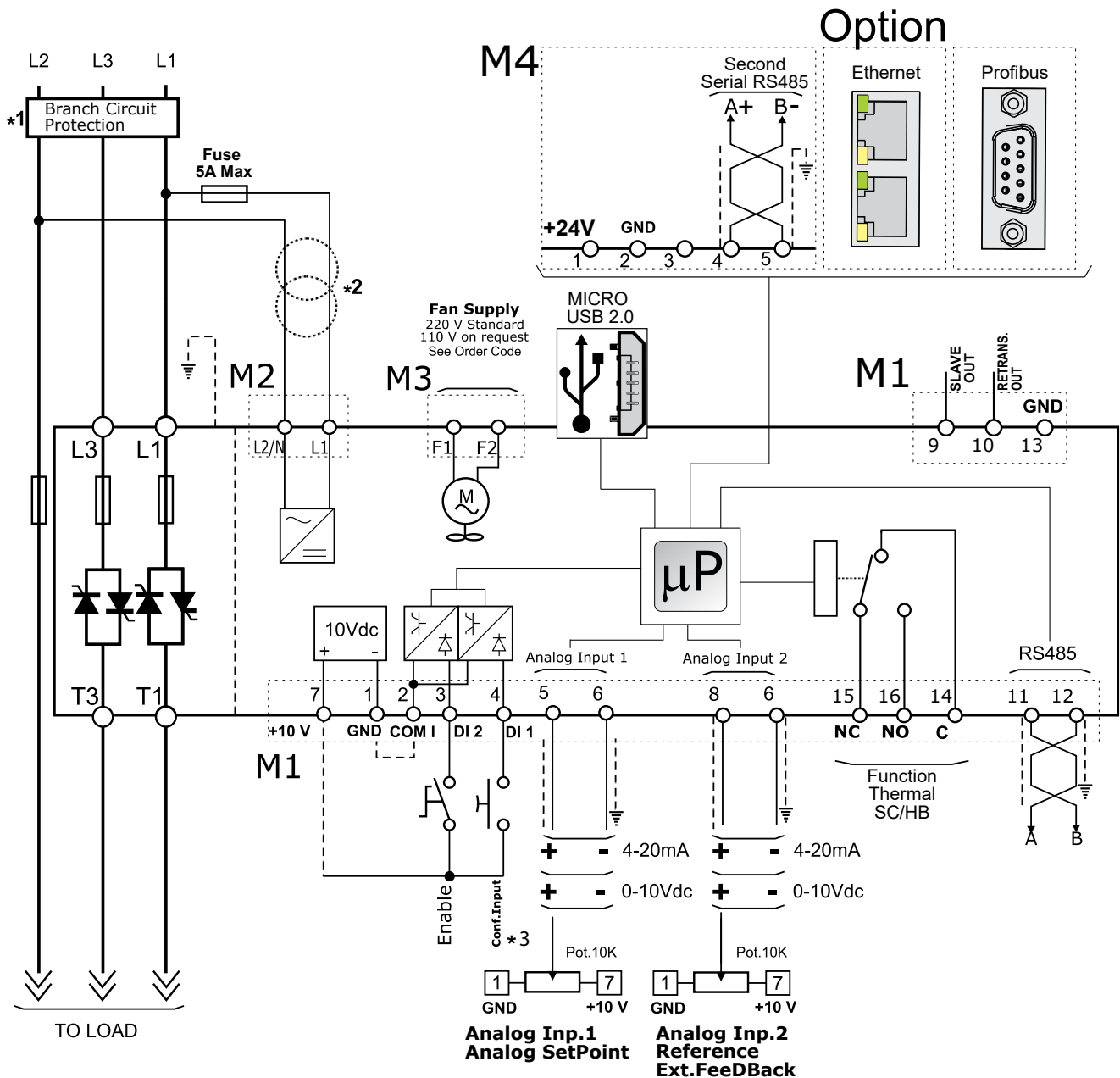

### NOTE:

\*1 The user installation must be protecting by electromagnetic circuit breaker or by fuse isolator. The Fuse must be branch circuit protection. For UL any listed UL branch circuit fuse would be acceptable as an external fuse, following national electric code guide for resistive heating of 125% load current rating to protect external wires.

\*2 The auxiliary voltage supply of the Relay C unit must be synchronized with load voltage power supply. If the Auxiliary Voltage (written on the identification label) is different from Supply Voltage (to the load), use an external transformer as designated.

\*3 For SSR input connection follow next page schematic

### 11.4.1 SSR Control input schematic

For SSR input follow the schematic below and configure Digital Input 1 as Fast enable.

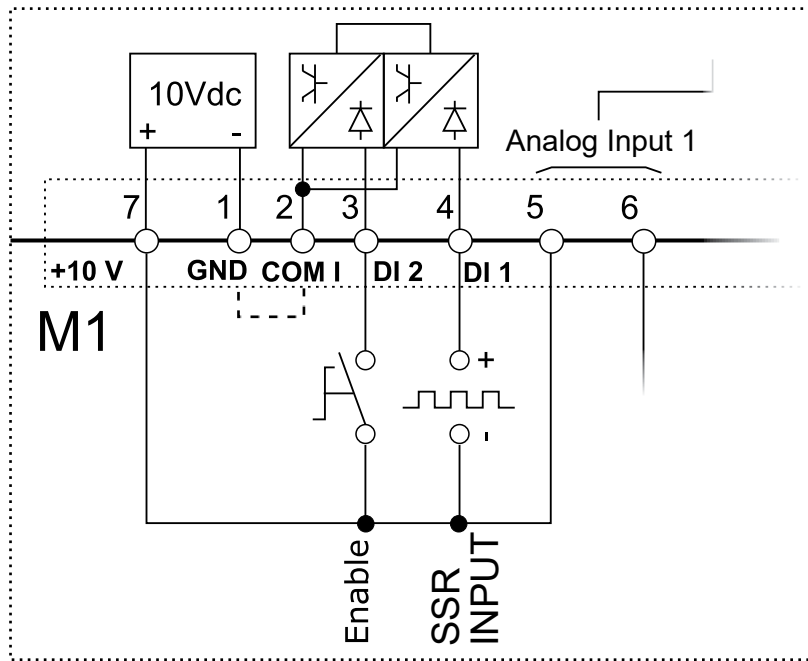

## 11.5 Connection diagram for 3 phases (control on 2 phases)



Caution: this procedure must be performed only by qualified persons.

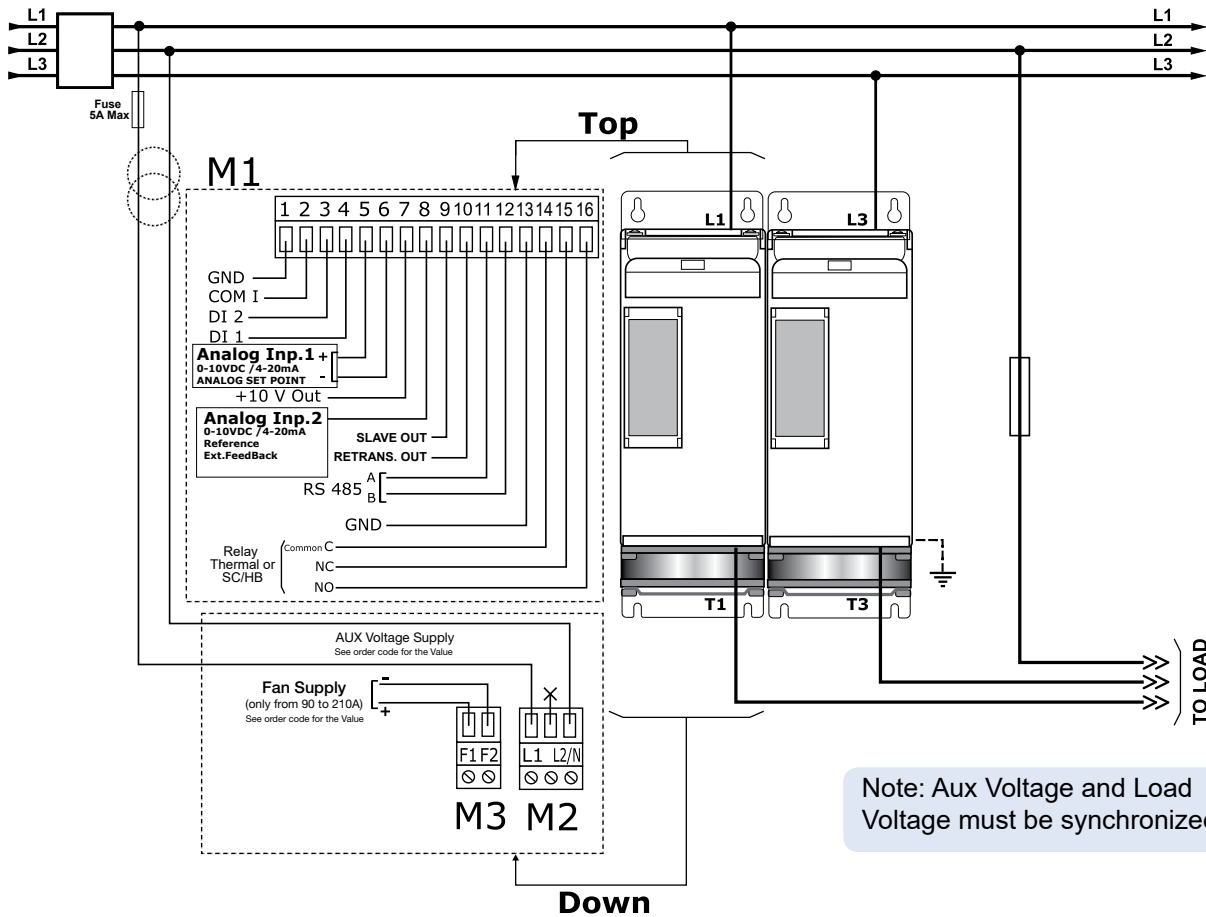

Note: Aux Voltage and Load Voltage must be synchronized

NOTE:

\*1 The user installation must be protecting by electromagnetic circuit breaker or by fuse isolator. The Fuse must be branch circuit protection. For UL any listed UL branch circuit fuse would be acceptable as an external fuse, following national electric code guide for resistive heating of 125% load current rating to protect external wires.

### Load Type

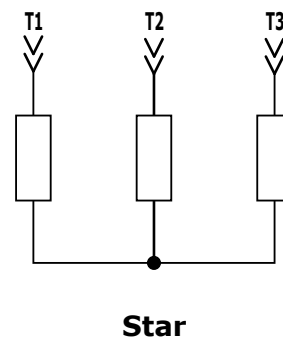
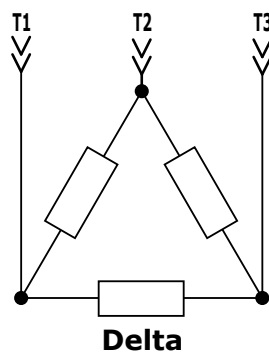



## 12. Control Panel

The Control Panel is placed on the front of the thyristor unit, on his display you can visualize the alarms, the input and output signals and all the configuration parameters.

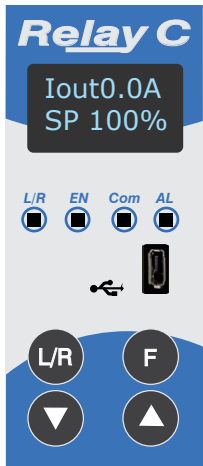

Output Current RMS

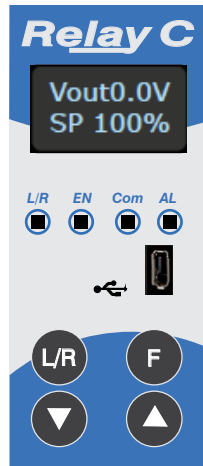

Output Voltage (RMS)

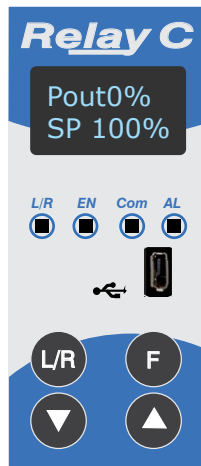

Output Power (Average)

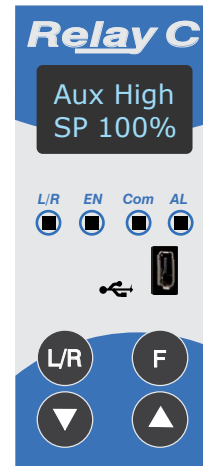

Alarms

On the home page the keys are used as follows:

Press..		To...
	Function	Scroll through the parameters on the home page
	Local/Remote	Switch between local and remote set point for power demand
	Up	Increment power demand set point when set to local
	Down	Decrement power demand set point when set to local
+		Press and hold for about two seconds to access the menus

To view the status parameters:

- Press Function once to advance from one parameter to the next

**To set the set point locally:**

- Press Local/Remote (Note: indicator 1 flashes steadily when set point is set locally)
- Use Down and/or Up to set the local set point.

## 12.1. Menu navigation

The menus are accessible using the control panel keypad and display.

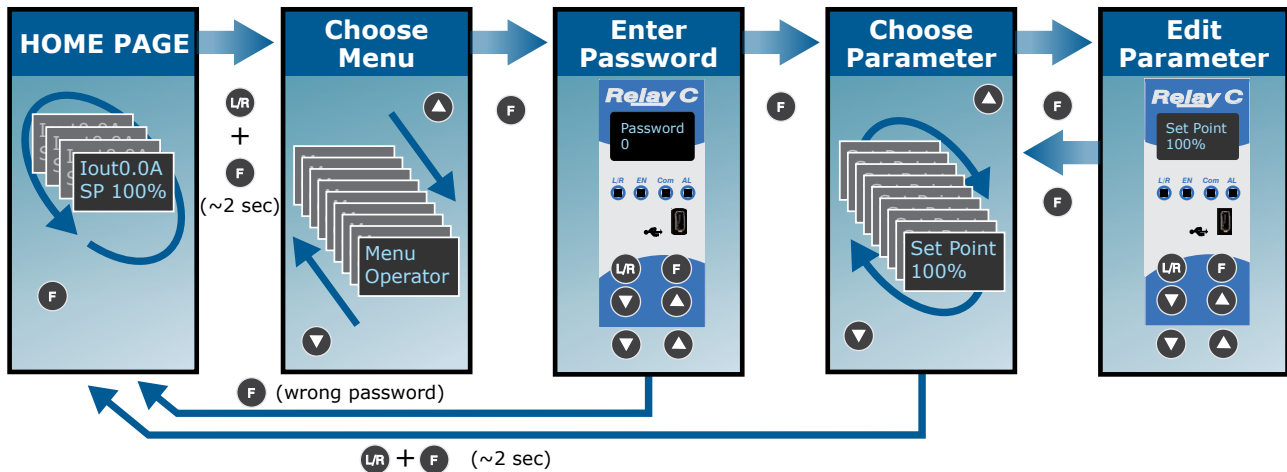

### To access a menu and edit a setting:

1. Press and hold Local/Remote and Function together **L/R** + **F** until the upper display flashes Menu.
2. Press Up **▲** to choose the menu. (Press down **▼** if you overshoot the menu you want).
3. Press function **F** to advance to the password prompt.
4. Use up **▲** and/or down **▼** to set the password (see the table).
5. Press function **F** to enter the password and advance to the first parameter of the menu.
6. Press Up **▲** to advance to the next parameter and repeat to reach the desired parameter.
7. Press function **F** to start editing the parameter. The parameter name flashes in the upper display.
8. Use Up **▲** and/or down **▼** to edit the parameter setting.
9. Press function **F** to enter the new setting. The parameter name stops flashing.
10. Press and hold local/remote and function together **L/R** + **F** for about two seconds to exit the menus.

Menu	Password	Parameter used to..
Operator	0	View measured values and basic settings including current, voltage and set point
Setup	2	Configure the power controller for the load
Adv Setup	10	Configure the operation and performance of the power controller in the application
Hardware	5	Configure the functions of the analog and digital inputs and outputs, and the retransmission parameters
Comm	3	Configure field bus communicating parameters
Monitoring	0	View measured and calculated values and other read-only parameters

## 12.2. Control panel led

The four indicators on the control panel show the general state of the power controller.

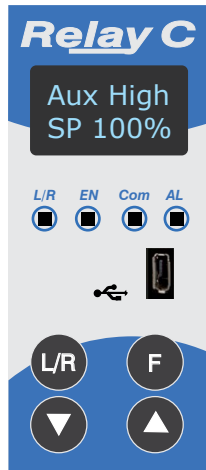

1	Local/Remote	Flashing	Power output set locally or via communications
		Off	Power output set remotely (via analog input)
2	Enable	On	Output enabled
		Off	Output disabled
3	Communications	Flashing	Active communications
4	Alarm	On	Active alarm
		Off	No alarm

## 12.3. Displayed alarms

Alarm or message	Description
Heater Break	Heater Break
Aux High	Aux voltage too high
Aux Low	Aux voltage too low
Watchdog	Communication Watchdog error
Line Loss	Line power not detected
SD Card Error	SD card error
Short Circuit	Short Circuit on SCR
SCR Over Temp	Thermal Switch over temperature

## 12.4. Parameter list

This chapter describes the parameter on the menus accessed via the control panel and Configurator software. To learn how to access the menus described below see “Menu navigation” chapter.

### 12.4.1 Operator menu

This section describes each item on the operator menu. Use this menu to view the measured values and basic settings of the power controller. **The password to access this menu is 0.**

Parameter Name	Description	Range	Unit	Modbus Address	Par. Type
SET POINT	View the set point	0 to 100	%	15	Read Only
V Output	Indicates the average (RMS) voltage of all phases	0 to 1023	V	10	Read Only
I Output	Indicates the average (RMS) current of all phases	0 to 1023	V	11	Read Only
Power	Indicates the average (RMS) power output	0 to 100	%	12	Read Only
V Input	Indicates the average (RMS) voltage input	0 to 65535	V	47	Read Only
Frequency	Indicates frequency of the power input	0 to 655.35	Hz	9	Read Only
Power Factor	Indicates power factor of the output power	0 to 1000		102	Read Only
Load $\Omega$	Indicates the resistance of the load	0 to 655.35	$\Omega$	46	Read Only
Out Scale	Indicates the percentage by which the power demand set point is scaled	0 to 100.0	%	16	Read Only
Nominal V	Indicates the user-set, nominal value for the line voltage input	0 to 1023	V	37	Read Only
Nominal I	Indicates the user-set, nominal load current	0 to 999.9	A	38	Read Only

### 12.4.2 Setup menu

This section describes each item on the setup menu. Use this menu to configure the power controller for the load. **The password to access this menu is 2.**

Parameter Name	Description	Range	Unit	Modbus Address	Par. Type
Out Scale	Set the percentage by which the set point is scaled. For example, if a 0 to 10V analog input providing the set point is 5V and output scaling is 80% then the effective set point is 40%	0 to 100.0	%	16	Read Write

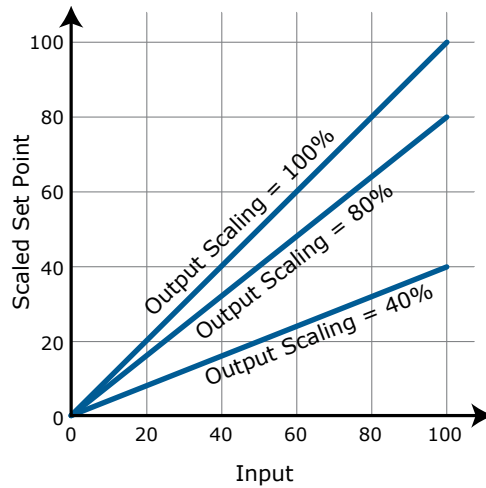

Parameter Name	Description	Default	Range	Unit	Modbus Address	Par. Type
Nominal V	Set the nominal value for the line voltage input	220V	0 to 1023	V	37	Read Write
Nominal I	Set the nominal load current	Maximum current	0 to 999.9	A	38	Read Write
Remote SP	Choose the source for the remote set point				61	Read Write

Option	Value
Analog Input 1	0
Analog Input 2	1

### 12.4.3 Advanced setup menu

This section describes each item on the advanced setup menu. Use this menu to configure the power switching, closed loop control of power and adjustable settings for data logging and heater bakeout. **The password to access this menu is 10.**

Parameter Name	Description	Default	Modbus Address	Par. Type
Firing	Choose the firing mode	3	18	Read Write

Option	Value
Zero Cross	1
Burst firing	3
DEFAULT: Burst Firing	3

Parameter Name	Description	Default	Range	Unit	Modbus Address	Par. Type
Min Cycles	Set the minimum number of On cycles and off cycles for burst firing	8	0 to 999.9	n°	20	Read Write
Cycle time	Set the duration of one on-off cycle in increments of 50mSec. Applies to zero crossing	60 (3 sec)	0 to 255 0 to 12,75 sec)		24	Read Write
Control Mode (Feed-back)	Choose the feed-back type	1			19	Read Write

Option	Description	Value
Voltage <sup>2</sup>	Voltage squared	0
None	No feed-back	1
Current <sup>2</sup>	Current squared	2
Voltage	Voltage	32
Current	Current	64
Power	Power	128
External	External signal via analog input 2	256
DEFAULT: None		1

Parameter Name	Description	Default	Range	Unit	Modbus Address	Par. Type
Prop band power	Set the gain for the main loop. A smaller proportional band yields a larger adjustment for a given deviation	10%	0 to 255	%	26	Read Write
Integral power	Set how aggressively the integral part of the control algorithm acts. A smaller settings yields a larger adjustment for a given deviation over a given time	50	0 to 255		27	Read Write
Htr Break sensitivity	Set the threshold of resistance that activates the Heater Break alarm. This setting is in percentage of the nominal load resistance	100%	0 to 100.0	%	29	Read Write
Htr Break delay	Set a delay between when the resistance drops below the value set for a heater break sensitivity and when the heater break alarm is indicated. This set increments of 50mSec	50 (2,5 sec)	0 to 255 (0 to 12,75 sec)		28	Read Write
Logging	Enable or disable data logging on the internal SD card	0			139	Read Write

Option	Value
Off	0
On	1
DEFAULT: Off	0

Parameter Name	Description	Default	Range	Unit	Modbus Address	Par. Type
Logging interval	Set how often data is logged	5 sec	0 to 255	sec	70	Read Write

#### 12.4.4 Hardware menu

This section describes each item on the hardware menu. Use this menu to configure how the inputs and outputs are used in the application. **The password to access this menu is 5.**

Parameter Name	Description	Default	Modbus Address	Par. Type
Analog In 1	Choose the type of signal to be measured by analog input 1	1	44	Read Write

Option	Description	Value
0-10V / 10k Pot	0 to 10 Vdc or 10,000Ω	1
4-20mA	4 to 20 mAdc	2
0-20mA	0 to 20 mAdc	3
DEFAULT: 0-10V / 10k Pot		1

Parameter Name	Description	Default	Modbus Address	Par. Type
Analog In 2	Choose the type of signal to be measured by analog input 2	1	105	Read Write

Option	Description	Value
0-10V / 10k Pot	0 to 10 Vdc or 10,000Ω	1
4-20mA	4 to 20 mAdc	2
0-20mA	0 to 20 mAdc	3
DEFAULT: 0-10V / 10k Pot		1

Parameter Name	Description	Default	Modbus Address	Par. Type
Analog In 2 Function	Choose how the signal measured by analog input 2 is used	0 or 1	116	Read Write

Option	Description	Value
Feed-back	External feed-back	1
Set Point	Power Demand set point	2
DEFAULT: Feed-back		1

Parameter Name	Description	Default	Modbus Address	Par. Type
Digital In 1 Function	Choose how the signal detected by digital input 1 is used	0	32	Read Write

Option	Description	Value
Enable	Enable power output	0
Voltage Feed-back	Use voltage feed-back when on	2
Local / Remote	Local when on / Remote when off	3
Set point Analog In 1/2	Select remote set point source: analog input 1 when off or analog input 2 when on	5
Logging	Enable logging	6
FastEn	Fast Enable, power on up to 10msec (only with phase angle firing)	8
DEFAULT: Voltage Feed-back		2

Parameter Name	Description	Default	Modbus Address	Par. Type
Digital In 2 Function	Choose how the signal detected by digital input 2 is used		33	Read Write

Option	Description	Value
Enable	Enable power output	0
Voltage Feed-back	Use voltage feed-back when on	2
Local / Remote	Local when on / Remote when off	3
Set point Analog In 1/2	Select remote set point source: analog input 1 when off or analog input 2 when on	5
Logging	Enable logging	6
FastEn	Fast Enable, power on up to 10msec (only with phase angle firing)	8
DEFAULT: Enable		0

Parameter Name	Description	Default	Modbus Address	Par. Type
Alarm Function	<p>Choose for which conditions the digital output indicates alarm. The output always indicate an alarm when the heat sink is over temperature. The digital output is energized for normal operating condition and de-energized when the power controller is off or when there is an alarm.</p> <p>Note!: The power controller monitors for heater break or short circuit condition only when included in the option selected for Alarm Output Function</p>	1	34	Read Write

Option	Description	Value
None	SCR is over temperature only	0
Heater Break	Heater Break or SCR is over temperature	1
Short Circuit	Short circuit or SCR is over temperature	2
HB / SC	Heater Break or Short circuit	3
These option may be set via communication only	Communication watchdog error	16
	Communication watchdog error or Heater Break	17
	Communication watchdog error or Short circuit	18
	Communication watchdog error, Heater Break or Short circuit	19
DEFAULT: Heater Break		1



Parameter Name	Description	Default	Modbus Address	Par. Type
Retransmit	Choose wich parameter is retransmitted by the analog output	12	68	Read Write

Option	Description	Value
None	Do not retransmit value	0
Set Point	Set point	15
V Output	RMS voltage output	10
I Output	RMS current output	11
Power	Average output power	12
DEFAULT: Power		12

Parameter Name	Description	Default	Range	Unit	Modbus Address	Par. Type
Retransmit Sale	Set the value of retransmitted parameter to be represented by the full scale of the analog output. See the table below	0	0 to 9999		124	Read Write

Retransmit	Recommended Retransmission Scaling	Resulting Signal (4 to 20 mADC)	Resulting Signal (0 to 20 mADC)	Resulting Signal (0 to 10 VDC)	Max Value
Set Point	100	4mADC = 0% 20mADC = 100%	0mADC = 0% 20mADC = 100%	0VDC = 0% 10VDC = 100%	100.0
V Output	<b>xV</b> where <b>x</b> is the Nominal Line Voltage	4mADC = 0V 20mADC = xV	0mADC = 0V 20mADC = xV	0VDC = 0V 10VDC = xV	999.9
I Output	<b>xA</b> where <b>x</b> is the Nominal Line Current	4mADC = 0A 20mADC = xA	0mADC = 0A 20mADC = xA	0VDC = 0A 10VDC = xA	999.9
Power	100	4mADC = 0% 20mADC = 100%	0mADC = 0% 20mADC = 100%	0VDC = 0% 10VDC = 100%	100

Parameter Name	Description	Default	Modbus Address	Par. Type
Retransmit Type	Choose type of signal for the retransmission output	1	69	Read Write

Option	Value
0-10V	1
4-20mA	0
0-20mA	2
DEFAULT: 0-10V	1

Parameter Name	Description	Default	Modbus Address	Par. Type
Startup Display	Choose wich parameter is displayed on the home page at power-up	1	60	Read Write

Option	Value
Current	0
Voltage	1
Power	2
DEFAULT: Voltage	1

### 12.4.5 Communication menu

This section describes each item on the communication menu. Use this menu to configure the communication options. **The password to access this menu is 3.**

Parameter Name	Description	Default	Modbus Address	Par. Type
Port 1 Baud	Choose the baud rate for the primary serial port	2	30	Read Write

Option	Value
9600	0
19200	1
38400	2
115200	3
DEFAULT: 38400	2

Parameter Name	Description	Default	Range	Unit	Modbus Address	Par. Type
Port 1 Address	Set the address for the primary serial port	1	0 to 255		31	Read Write
Port 2 Baud	Choose the baud rate for the primary serial port	2			45	Read Write

Option	Value
9600	0
19200	1
38400	2
115200	3
DEFAULT: 38400	2

Parameter Name	Description	Default	Modbus Address	Par. Type
Watchdog	Enable or disable the watchdog on the primary serial port	0	142	Read Write

Option	Value
Off	0
On	1
DEFAULT: Off	0

Parameter Name	Description	Default	Range	Unit	Modbus Address	Par. Type
Watchdog Reset Time	Set the amount of time to wait for a message before triggering the watchdog error	5	0 to 255	Sec	143	Read Write
Wi-Fi Address	Indicate the IP address of the WiFi connection in the power controller		0 to 255		94-95 96-97	Read Only
Ethernet Address	Indicate the IP address of the power controller with the Modbus TCP or Profinet <b>option</b>		0 to 255		71-72 73-74	Read Only
Ethernet Subnet	Indicate the subnet mask of the the power controller with the Modbus TCP or Profinet <b>option</b>		0 to 255		75-76 77-78	Read Only
Ethernet Gateway	Indicate the gateway address of the the power controller with the Modbus TCP or Profinet <b>option</b>		0 to 255		79-80 81-82	Read Only
Host Name	Indicate the WiFi hotspot name also known as the Service Set Identifier (SSID). Two (one byte) character per register, 16 Character total		0 to 65535		83-84 85-86 87-88 89-90	Read Only
Port 2 Address	Set the address for the secondary serial port or the Profibus Address	0	0 to 1024		122	Read Write
Port 2	Indicates the type of secondary communication port				119	Read Write

Option	Description	Value
Disabled	No secondary communication port	0
Ethernet	Modbus TCP or ProfiNet	1
RS-485	RS-485	2

Parameter Name	Description	Default	Modbus Address	Par. Type
Wi-Fi	Enable or disable WiFi communication	0	120	Read Write

Option	Value
Off	0
On	1
DEFAULT: Off	0

#### 12.4.6 Monitoring menu

This section describes each item on the monitoring menu. Use this menu to view the states of digital input, values of analog input and information about the power controller such as serial number and software version. **The password to access this menu is 0.**

Parameter Name	Description	Modbus Address	Par. Type
Digital In 1	Indicate the state of the signal to digital input 1	13 bit8	Read Only

Option	Value
Off	0
On	1

Parameter Name	Description	Modbus Address	Par. Type
Digital In 2	Indicate the state of the signal to digital input 2	13 bit9	Read Only

Option	Value
Off	0
On	1

Parameter Name	Description	Modbus Address	Par. Type
Enable	Indicate whether or not the power controller is enabled. The enable signal must be on for the unit to output power to the load	14 bit2	Read Only

Option	Value
Off	0
On	1

Parameter Name	Description	Modbus Address	Par. Type
Set Point Source	Indicate whether the power controller is local or remote set point mode	14 bit1	Read Only

Option	Description	Value
Remote	Set Point via analog input	0
Local	Set Point via keypad or communication	1

Parameter Name	Description	Range	Unit	Modbus Address	Par. Type
Analog In 1	Indicates the percent of full scale measured by analog input 1	0 to 100.0	%	138	Read Only
Analog In 2	Indicates the percent of full scale measured by analog input 2	0 to 100.0	%	137	Read Only
Version	Indicates the software version number (x.xx.x)	0 to 65535		48	Read Only
Release	Indicates the software release date year and week (yyww)	0 to 65535		49	Read Only
Unit Type	Indicates the type of power controller			36	Read Only

Option	Description	Value
1 Leg	Single Phase	7
2 Leg	Two Leg, three phase	8
3 Leg	Three Leg, three phase	9
3 Leg PA	Three Leg, three phase with phase angle capability	9999

Parameter Name	Description	Range	Unit	Modbus Address	Par. Type
Max Voltage	Indicates the maximum voltage rating of the power controller	0 to 1023	V	41	Read Only
Max Current	Indicates the maximum current capacity of the power controller	0 to 9999	A	62	Read Only
Aux Voltage	Indicates the measured line voltage	0 to 1023	V	43	Read Only
Serial Number	Indicates the serial number of the power controller	0 to 9999		149-150 151-152	Read Only
SCR Temperature	Indicates whether the SCR is below or above the factory-set trip point			127	Read Only

Option	Description	Value
Disabled	No sensor present / temperature below limit	0
Over Temp	Over temperature	130

## 13. Using the Configurator

Configurator software can be used like an alternative of the power controller's keypad and set the advanced features not available via the power controller's onboard user interface. Here will explain how use it.

### 13.1 Typical Uses

The software may be used during commissioning to:

- set internal parameter do determine how the power controller operates and performs;
- save and restore a setup, copy or clone one power controller to another;
- on a day-to-day basis to monitor operation and power usage;
- to examine performance in more detail to determine if any corrective actions are needed.

### 13.2 Communicating with power controllers

When commissioning the power controller, may be useful to connect via the USB port located below the control panel's display a computer, is so possible configure and examine the settings of controller.

The controller's electronics is powered vis USB cable, so is possible inspect it before applying power.



**NOTE!** the power of the USB port is limited and not designed to power industrial cards, so it manages to feed only the essential parts of the electronics. For complete control, you need to power up the auxiliaries of the power controller.

### 13.3 Recipes

A recipe is a file that store the settings of power controller internal parameter.

Is used to save a power controller configuration or restore an existing configuration in a power controller.

#### 13.3.1 Upload a recipe

A recipe is created using upload function Configurator software and saving it as a file on the computer.

#### 13.3.2 Download a recipe

An existing recipe can be download to a power controller using download function in Configurator software

### 13.4 How To

Here it is described step-by-step the procedures for common task.

#### 13.4.1 Install and communication with the power controller

##### Procedure to install the Configurator:

1) Locate the installer:

- On <https://www.west-cs.com>

link is possible Download it

2) Double-click on the installer program to start installation.

3) Follow the on-screen instructions.

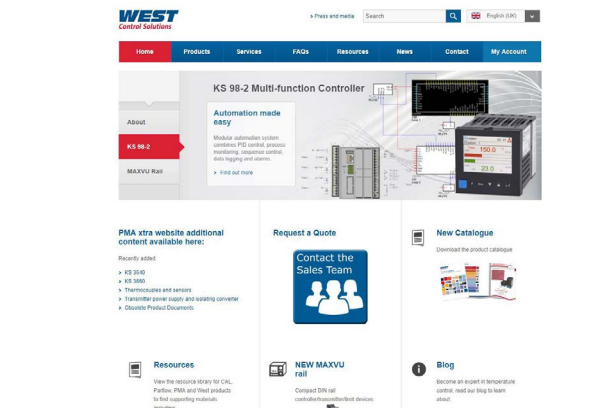

## Procedure to communicate with a power controller:

### 1) if used direct USB connection:

- Connect the USB cable between the computer and the micro USB connector on the power controller's keypad
- if necessary, Wait for the USB driver to install.

### 2) if used RS-485 connection connect the power controller terminal to computer RS485 port. Usually the standard pc do not have a RS485 port so a USB-to-485 converter is required.

- 3) Launch the Configurator software and select
  - **Relay C:** for single phase
  - **Relay C:** 3PH for 3 phase power controller

### 4) Choose Serial Port From the **Setting -> Serial Port** menu

### 5) In value **Port**, select the connected COM port to the power controller (see the note below)

### 6) To verify communications, click **Test**

### 7) Click **OK**



**NOTE!** to determine which port is connected to the power controller, you can:

- In the Windows Device Manager under Ports (COM & LPT), looking for the COM port named "LPC USB VCOM Port (COMx)" where x is the port number
- In the configurator software:
  - open the software without connect the unit and see the available com port on con port window setting,
  - close the com setting window,
  - connect the USB cable to the power controller (wait for the USB driver to install if necessary), - open the com setting window and see the added com number and select it.

## 13.5 Using the configurator

After software has been installed, communication has been set up and model type selected, is possible operate with power controller.

### 13.5.1 To view or save a power controller's settings using "Simple" view section:

- 1) Click **Simple**, if not already on the simple view
- 2) Click **Upload from unit**
- 3) Set the address, if necessary
- 4) Click **READ->**
- 5) Wait for the software to read the parameter settings
- 6) Click **OK**
- 7) If need save the settings in a recipe file:
  - Click **Save**
  - Name the recipe
  - Click **Save** button



**NOTE!** In the simple view the change are not "live", so to take effect the change in simply section is necessary download it with download procedure.

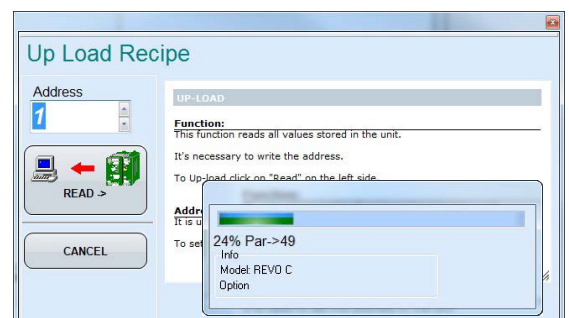
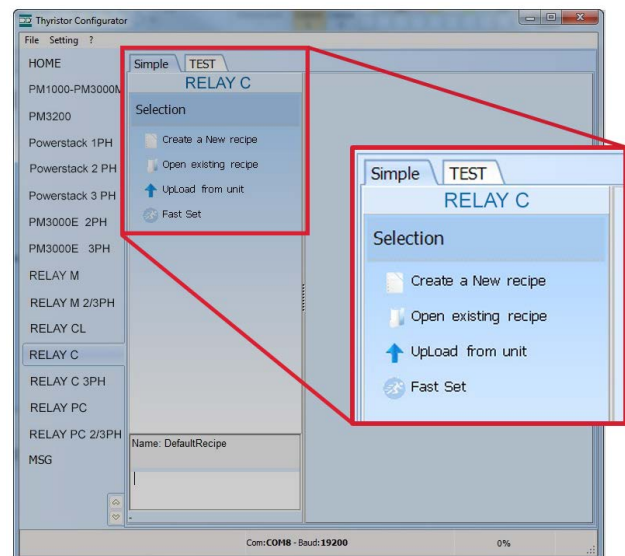
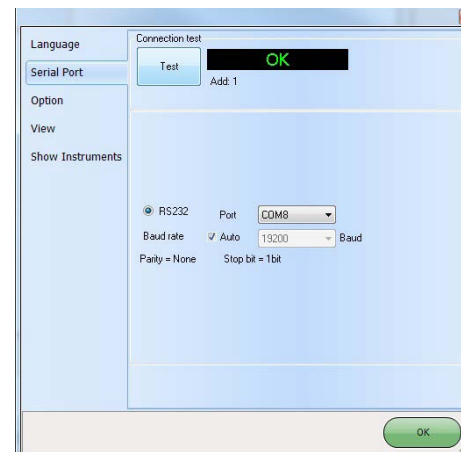
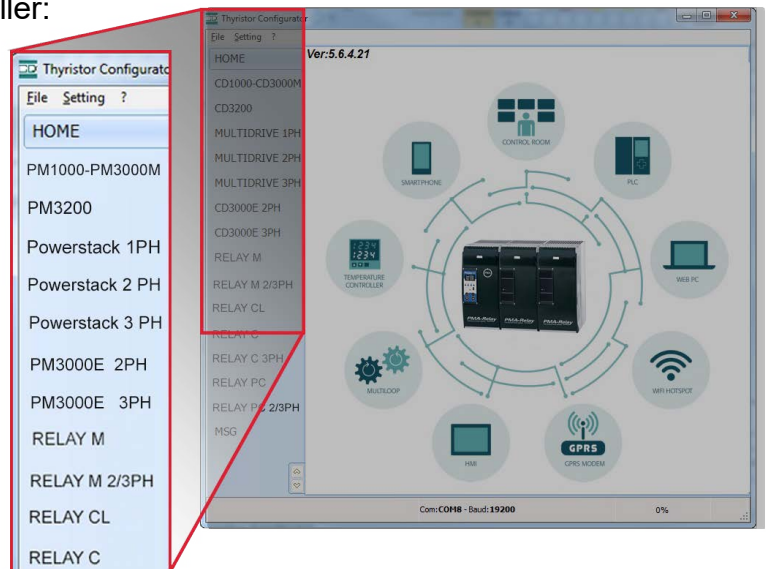

### 13.5.2 To edit a setting in a recipe:

- 1) Click **Simple**, if not already on the simple view
- 2) Click **Open** existing recipe
- 3) Locate and select the recipe file and click **Open**
- 4) Click **OK**
- 5) Click the menu with the setting you want to change

- **SETUP**

- **ADVANCED SETUP**

- **HARDWARE**

- **COMMUNICATIONS**

- 6) Select the value you want to change

- 7) Edit the value with the increment and decrement buttons in the field or type the new value and press the Enter key

- 8) Repeat steps 5 to 7 for all the changes you want to make

- 9) To save the settings in a recipe file:

- Click **Save**

- Name the recipe

- Click **Save** button

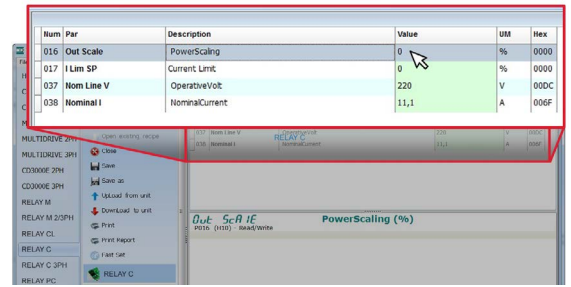

### 13.5.3 To download a recipe file into a power controller:

- 1) Click **Simple**, if not already on the Simple view
- 2) Click **Open** existing recipe
- 3) Locate and select the recipe file and click **Open**
- 4) Click **OK**
- 5) Click **Download to unit**
- 6) Set the address, if necessary
- 7) Click **SEND->**
- 8) Wait for the software to write the parameter settings
- 9) Click **OK**

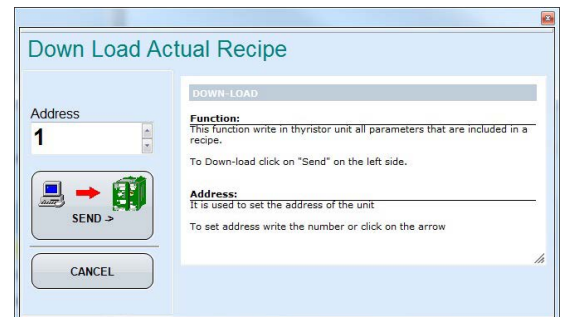

### 13.5.4 To monitor a power controller with the test view:

- 1) Click **Test**, if not already on the test view
- 2) Click **Online**

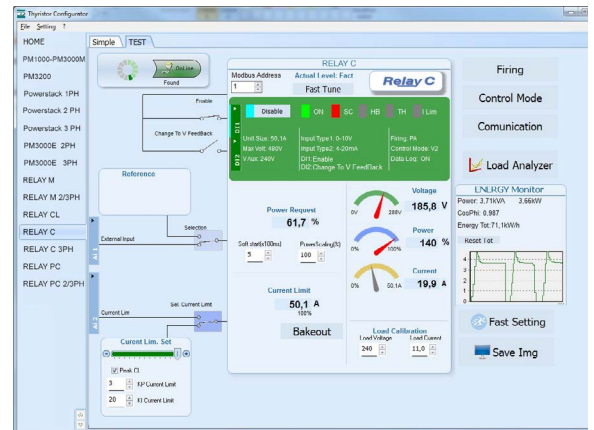

### 13.5.5 To log in on the test view to change the digital input and analog input functions:

- 1) Click the **Access Level** value (zero when logged out)
- 2) Type the password: **1111**
- 3) Click **OK**

### 13.5.6 To log out the test view:

- 1) Click the **Access Level** value.
- 2) Click **Log out**.
- 3) Click **OK**.

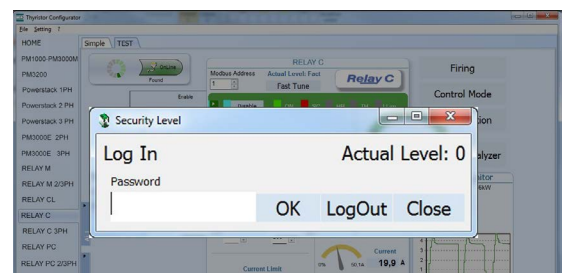



### 13.5.7 To view data on the scope:

- 1) Click **Test**, if not already on the test view
- 2) Click **Online**
- 3) Click **Load Analyzer**
- 4) For each of up to three channels (Ch 1 to Ch 3):
  - With **PV1** choose the value to monitor
  - Select Show
  - Click the colour switch to change the colour
  - Click the button to turn the channel on.



### 13.5.8 To reset the power totals:

- 1) Click **Test**, if not already on the test view
- 2) Click **Online**
- 3) Click **Reset Totals**
- 4) Click **Yes**

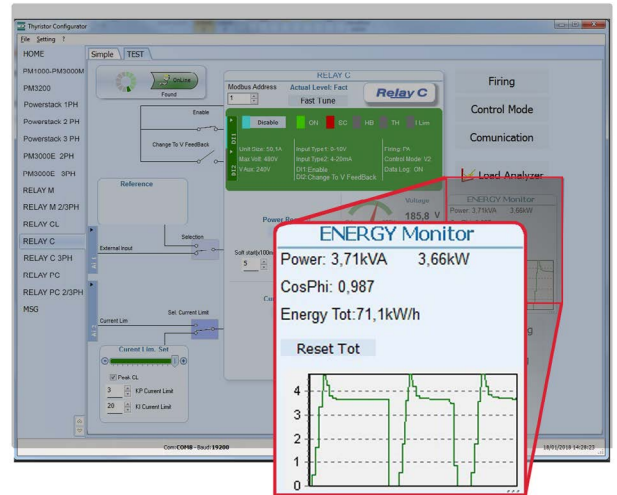

### 13.5.9 Setting up and using data logging

#### To set up data logging:

- 1) Click **Test**, if not already on the test view
- 2) Click **Online**
- 3) Click **Load Analyzer**
- 4) On the **Load Analyzer** view click **Data Log**
- 5) In the **Data Log** window ensure the slider is set to **Log Enabled**
- 6) Click **Set Time**
- 7) If necessary Set the date and time and close the date/time window
- 8) Set **Log Time** to the number of seconds between records
- 9) Click **Connect**
- 10) Click **Config**
- 11) Click **Load Configuration** to view the current list of logged parameters
- 12) For up to ten parameters to log:
  - Click **+** to add a parameter to the list
  - In a row in the list either: Type a parameter's Modbus address in the **Par** field
- OR
  - Select the parameter from the drop down list in the **Name** field
- 13) Click **Write Configuration** to send the parameter list to the controller
- 14) Click **Close**
- 15) Click **Disconnect**
- 16) Close the **Data Log** window

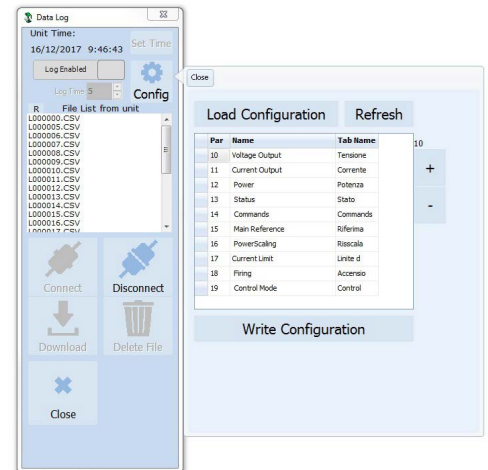

### 13.5.10 To retrieve a data log file from the power controller:

- 1) Click **Test**, if not already on the test view
- 2) Click **Online**
- 3) Click **Load Analyzer**
- 4) Click **Connect**
- 5) Select a file from the list
- 6) Click **Download**
- 7) Select a location and click **Save**
- 8) Wait for the file to download. This can take up to ten minutes for the largest file
- 9) To delete the log file from the controller memory, if desired, click **Delete File**
- 10) Click **Disconnect**
- 11) Close the **Data Log** window
- 12) Close the **Load Analyzer** window

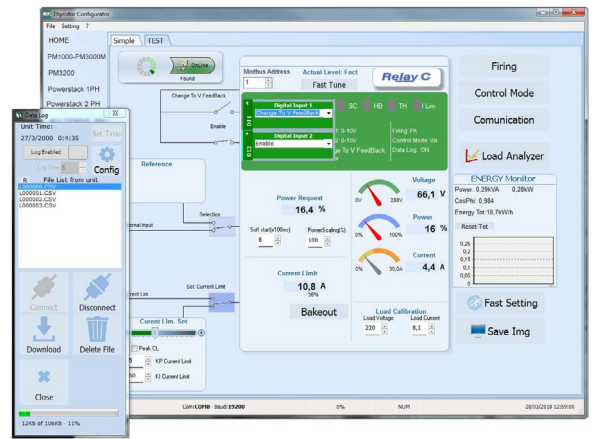

## 13.6 Software General information

Here it is described the Configurator Software and how use it.

### 13.6.1 Program window

#### Main Menu

Access these menus.

#### File menu

**Exit:** close the program

#### Setting menu

**Language:** open language Settings dialog box

**Serial Port:** open Serial Port dialog box

**Option:** open General Option dialog box

#### ? (Help) menu

**Message Log:** open a serial communication message view

**About:** displays the About dialog with the program name and version and contact information

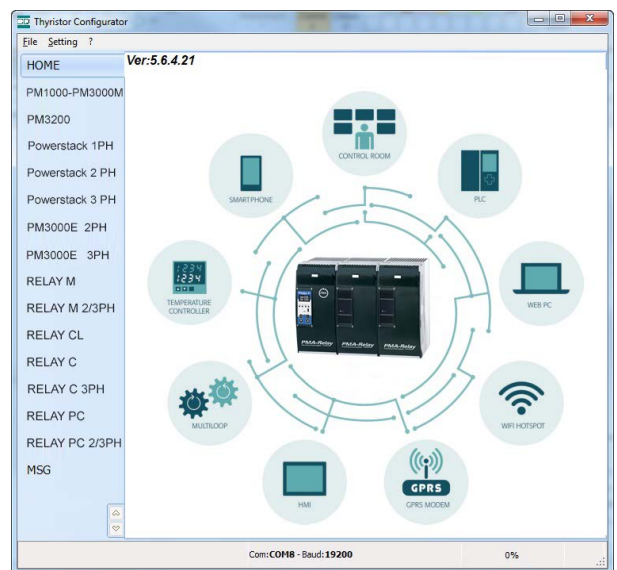

#### Instruments selector

Select the right instrument to use:

**HOME:** the default view

**Relay C:** open the Simple and Test views for a single-phase power controller

**Relay C 3PH:** access the Simple and Test views for a three-phase power controller

**MSG:** opens a serial communication message view

#### Status Bar

Indicates information such as time and date, communications port and baud rate.

### 13.6.2 Simple section

This section is used to create, save, upload and download recipes of parameters settings. Can be used also to see the settings in a controller.

Simple page is the default page when select the model using the Model Button, but If not selected is possible access it clicking the Simple tab below the main menu.



**NOTE!** This section is not "OnLine" so the parameter values are not updated continuously. They are read only when you upload them from the power controller.

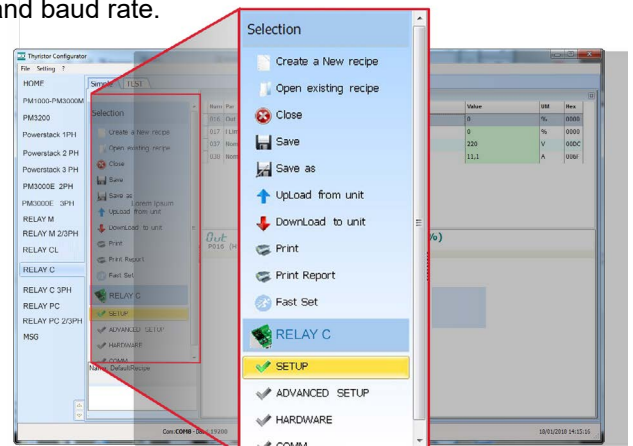

To manage recipe click on:

**Create a New recipe:** create a recipe file with the standard default settings

**Open existing recipe:** open an existing recipe file

**Upload from unit:** create a new recipe with the value uploaded from a connected power controller

**Close:** close the current recipe

**Save:** save the recipe in a file

**Save as:** save a copy of the recipe in a file

**Download to unit:** send the current recipe parameters in the connected power controller

**Print:** print the recipe (see sample at right)

**Print report:** print the recipe (see sample at right)

RELAY C	Display Name	Desc	Val
RELAY C	Display Name	Desc	Val
<b>SETUP</b>			
P018 RW	OutScale	PowerScaling	0%
P017 RW	I Lim SP	Current Limit	0%
P020 RW	NomLine V	OperativeVob	220V
P020 RW	NomLine I	NominalCurrent	11.1A
<b>ADVANCED SETUP</b>			
P016 RW	Energy	Prog	0%
P019 RW	Modem	Control Mode	1/2
P022 RW	Modem	IC Drive	0
P023 RW	SoftStart	SoftStart	0
P024 RW	SoftStart	SoftStart	0
P025 RW	SoftStart	SoftStart	0
P026 RW	Power	HP Drive	0%
P027 RW	Power	HP Drive	0%
P028 RW	Power	HP Drive	0%
P029 RW	Power	HP Drive	0%
P030 RW	Power	HP Drive	0%
P031 RW	Power	HP Drive	0%
P032 RW	Power	HP Drive	0%
P033 RW	Power	HP Drive	0%
P034 RW	Power	HP Drive	0%
P035 RW	Power	HP Drive	0%
P036 RW	Power	HP Drive	0%
P037 RW	Power	HP Drive	0%
P038 RW	Power	HP Drive	0%
P039 RW	Power	HP Drive	0%
P040 RW	Power	HP Drive	0%
<b>HARDWARE</b>			
P014 RW	IM	Commands	OFF
P015 RW	DIEnable	Configuration Digital Inout_1	OFF
P016 RW	DIEnable	Configuration Digital Inout_2	OFF
P017 RW	DIEnable	Configuration Base Output	OFF
P018 RW	DIEnable	Configuration Base Output	OFF
P019 RW	DIEnable	Configuration Base Output	OFF
P020 RW	DIEnable	Configuration Base Output	OFF
P021 RW	DIEnable	Configuration Base Output	OFF
P022 RW	DIEnable	Configuration Base Output	OFF
P023 RW	DIEnable	Configuration Base Output	OFF
P024 RW	DIEnable	Configuration Base Output	OFF
P025 RW	DIEnable	Configuration Base Output	OFF
P026 RW	DIEnable	Configuration Base Output	OFF
P027 RW	DIEnable	Configuration Base Output	OFF
P028 RW	DIEnable	Configuration Base Output	OFF
P029 RW	DIEnable	Configuration Base Output	OFF
P030 RW	DIEnable	Configuration Base Output	OFF
P031 RW	DIEnable	Configuration Base Output	OFF
P032 RW	DIEnable	Configuration Base Output	OFF
P033 RW	DIEnable	Configuration Base Output	OFF
P034 RW	DIEnable	Configuration Base Output	OFF
P035 RW	DIEnable	Configuration Base Output	OFF
P036 RW	DIEnable	Configuration Base Output	OFF
P037 RW	DIEnable	Configuration Base Output	OFF
P038 RW	DIEnable	Configuration Base Output	OFF
P039 RW	DIEnable	Configuration Base Output	OFF
P040 RW	DIEnable	Configuration Base Output	OFF
<b>COMM</b>			
P009 RW	PortAddr	SerialPort	3040
P010 RW	PortAddr	SerialPort	1440
P011 RW	PortAddr	SerialPort	800
P012 RW	PortAddr	SerialPort	0
P013 RW	PortAddr	SerialPort	0
P014 RW	PortAddr	SerialPort	0
P015 RW	PortAddr	SerialPort	0
P016 RW	PortAddr	SerialPort	0
P017 RW	PortAddr	SerialPort	0
P018 RW	PortAddr	SerialPort	0
P019 RW	PortAddr	SerialPort	0
P020 RW	PortAddr	SerialPort	0
P021 RW	PortAddr	SerialPort	0
P022 RW	PortAddr	SerialPort	0
P023 RW	PortAddr	SerialPort	0
P024 RW	PortAddr	SerialPort	0
P025 RW	PortAddr	SerialPort	0
P026 RW	PortAddr	SerialPort	0
P027 RW	PortAddr	SerialPort	0
P028 RW	PortAddr	SerialPort	0
P029 RW	PortAddr	SerialPort	0
P030 RW	PortAddr	SerialPort	0
P031 RW	PortAddr	SerialPort	0
P032 RW	PortAddr	SerialPort	0
P033 RW	PortAddr	SerialPort	0
P034 RW	PortAddr	SerialPort	0
P035 RW	PortAddr	SerialPort	0
P036 RW	PortAddr	SerialPort	0
P037 RW	PortAddr	SerialPort	0
P038 RW	PortAddr	SerialPort	0
P039 RW	PortAddr	SerialPort	0
P040 RW	PortAddr	SerialPort	0

To edit the actual recipe values click a parameter menu name:

**SETUP**

**ADVANCED SETUP**

**HARDWARE**

**COMMUNICATIONS**

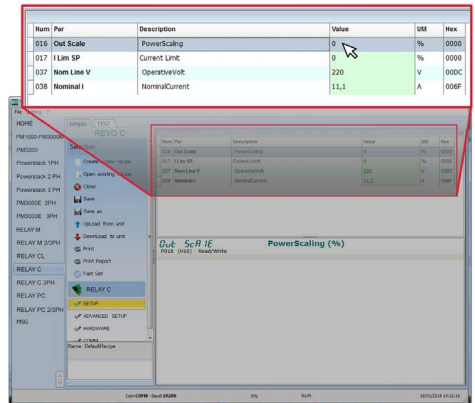

And after click on the value and modify it.



**NOTE!**

Changes to the values here affect the open recipe only. To apply these changes to the power controller settings, download them to the power controller using the Download to unit option.

**13.6.3 Test section**

This section is used to monitor and adjust the operation of the power controller in real time using RS485 or USB communication port.

After select the model, is possible access to this section clicking the "TEST" tab below the main menu

Operating on TEST Section:

**Online button:** is the button to start or stop communication updates with the power controller

After communication start a green communication status indicator sweeps clockwise when the software is communicating right with a power controller, is the connection link is broken the color will become red

**Address:** value used to set the power controller address

**Access Level:** click the value to log in or out. Default Password address is "1111".

**To configure and monitor the digital inputs:**

**Digital input states and functions:**

show whether each input detects an open or closed circuit and the function the input performs

**Digital Input States and Function Selectors:**

set the function for each digital input. Click DI1 or DI2 to expand the options.

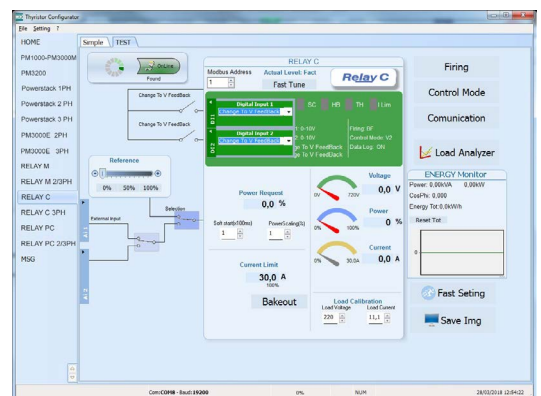
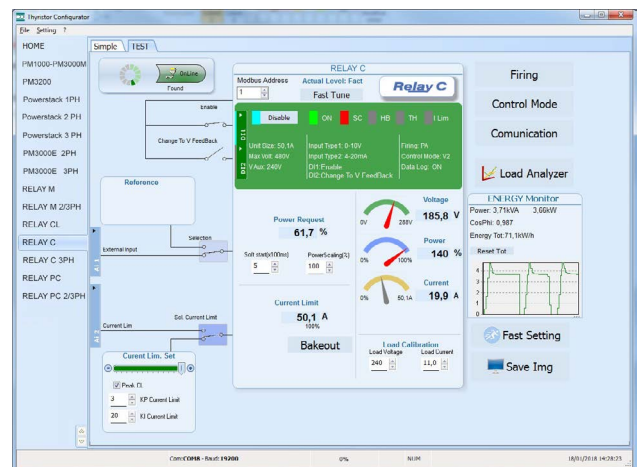

## Status and Setup Indicators:

**Digital input status:** light on when the input is a a closed circuit

**Enable indicator:** light on when the power controller is enabled

**Enable/Disable button:** click on to enable the power controller if a digital input is not configured for this function

**ON indicator:** light on when there is demand for the output to be on

**SC indicator:** light on when there is a shorted SCR alarm active

**HB indicator:** light on when there is a heater break alarm active

**TH indicator:** light on when the heat sink over temperature alarm is active

**I Lim indicator:** light on when the load current exceeds the current limit setting

**Unit Size:** Indicate the maximum rated current of the power controller

**Max Volt:** indicate the maximum rated voltage for the power controller

**V Aux:** indicate the voltage the auxiliary input is set to use for powering the electronics

**Input Type 1:** indicate the signal analog input 1's type

**Input Type 2:** indicate the signal analog input 2's type

**DI1:** indicate digital input 1's function

**DI2:** indicate digital input 2's function

**Firing:** indicate the firing type the power controller is set to use

**Feedback:** indicate the feedback type the power controller is set to use

**Data Log:** indicate the Data Log status

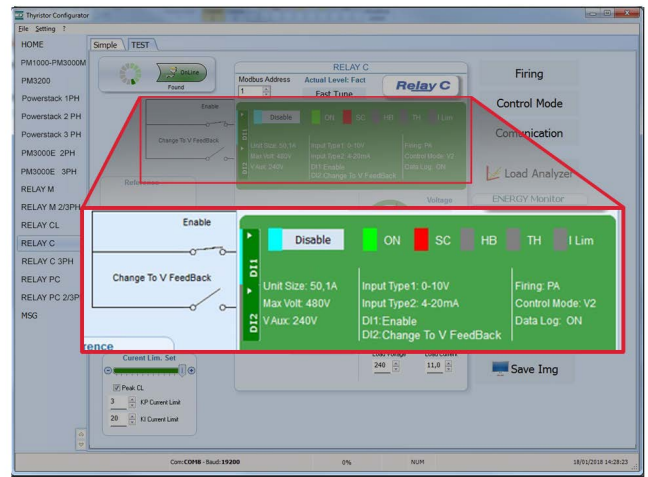

## Buttons setup options:

**Firing:** view and set the firing type and the associated parameters

**Feedback:** view and set feedback type

**Communication:** view and set communication options for ports, protocols and fieldbus

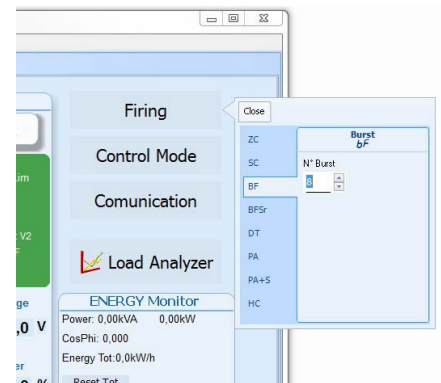

## Configure and monitor the analog inputs:

**Analog Input 1:** click Ai 1 to view the signal type

**Input Local/Remote selection button:** click to toggle between using the signal received at analog input 1 (remote) or the slider (local) to set the set point.

**Reference:** drag the slider, click the increment (+) or decrement (-) buttons or click one of the three percentages (0%, 50% or 100%) to set the set point when the set point source is set to local.

**Analog Input 2:** click Ai 2 to view the signal type and function

## To configure and monitor the power controller:

**Power Request:** show the set point signal from analog input 1.

the value is a percent of full scale or can be set with the reference slider

**Soft Start Time:** show the time over which set point changes are ramped

**Output Scaling:** show the scaling applied to the set point signal before it is used by the control loop

**Voltage indicator:** show RMS load voltage

**Power indicator:** show RMS load power

**Current indicator:** show the RMS load current

**Current Limit Set:** indicates the current limit set point

**Bakeout button:** click to view and set the heater bake out feature options

**Load Calibration:** set and view the nominal line voltage and nominal load current settings for the application.

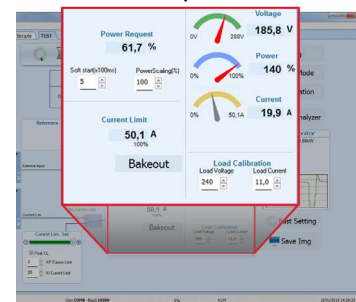



**NOTE!** The Load Calibration settings, Load Voltage and Load Current define 100% power for the load.

**Energy Monitor:** indicates power, power factor and energy usage over time which may be reset with the **Reset Tot** button.

**Data Log:** If present is used to configure the data logging feature data logs.

**Save Image:** click to save a JPEG file with an image of the test Page.

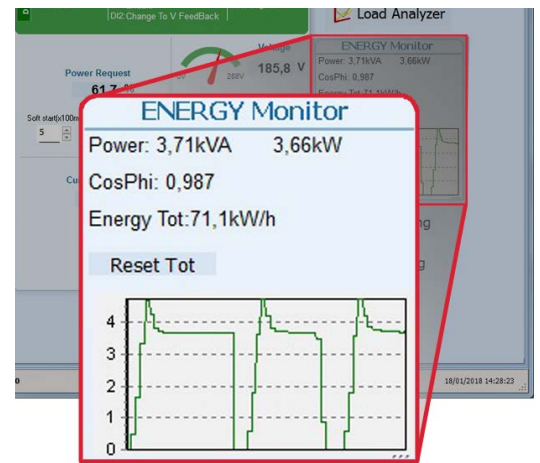

### 13.6.4 Load analyzer

**Load Analyzer is used for monitoring values graphically represent**

Click on **Load Analyzer** button on the test page will open Load Analyzer window.

Is possible see 3 channels (Ch 1, Ch 2 and Ch 3). For each channel configure a pen on the graph:

**On/Off button:** click to start trending data reading

**PV:** choose the parameter to trend

**Show:** set this option to display or hide the trend

**Show Mark:** set this option to display data markers along the trend in the graph area

**Live!:** click to view a see the current wave form on a graph.

**Data Log:** click to open the Data Log window.

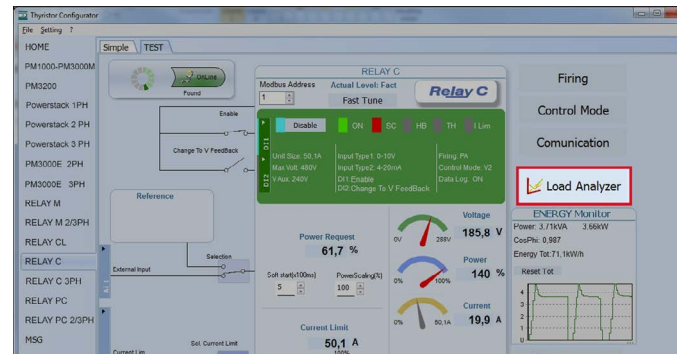

The **History** options to control the movement of the chart:

**Scroll left-click:** move the chart left to view more recent data

**Stop/Play-click:** toggle the live view or historical view of graphic signal

**Scroll right-click:** move the chart right to view older data

The **Actions** to:

**Clear:** to clear the data from the graph

**Save:** to save a JPEG image of the **Load Analyzer** window with the current trends

**Export:** to open a window that includes the trend graph and table with the currently displayed data that can be saved as a JPEG or exported to a CSV file.



Use the **X – Scale** settings to adjust the horizontal (time) axis:

**Min:** set the minutes of data displayed

**Sec:** set the seconds of data displayed

**Filter:** set this option to filter the data

Use the **Y – Scale** settings to adjust the vertical (percent of full scale) axis

**Max:** set the maximum value for the vertical axis

**Reset:** click to reset the vertical axis scaling



**NOTE!** Use the increment (up arrow) and decrement (down arrow) buttons to adjust the x and y scales. Numeric entry does not allow the full range of values to be set.

### 13.6.5 Data log window

In the power controller the data log window is used to manage files and set up logging parameter like log interval time and date/time in rtc

**Log Enabled/Log Disabled slider:** Enable and disable data logging function.

**Log Time:** the time between data log records in seconds

**Config:** opens the data log configuration window to customize the variable to log

**File List:** lists the data log files available in the power controller

**Connect:** the power controller enter in log mode and permit the file manage

**Disconnect:** the power controller close the log mode

**Download:** download the selected file from the power controller to the computer

**Delete File:** erases the selected file from the power controller

**Close:** closes the Data Log window and close the log mode on power controller

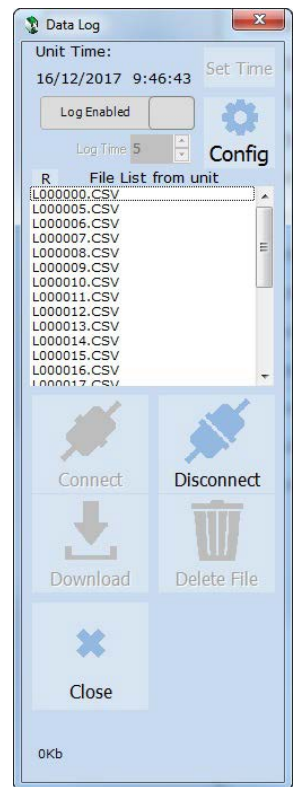

### 13.6.6 Data log configuration window

Data log configuration window is used to view and set the parameter log table.

**Close:** closes the window

**Load Configuration:** refresh and displays the list of parameters being logged

Logged parameters list-the parameters configuration table

**Par:** view or enter the Modbus address of the parameter to log



**NOTE:** is possible to set all parameter number describe in the Modbus communication manual

**Name:** view or choose by name of common parameter to log

**Tab Name:** indicates the name of the logged parameter as displayed in the log file

**+ button:** adds a row to the list

**- button:** removes the last row from the list

**Write Configuration:** sends the list of parameters to be logged to the controller

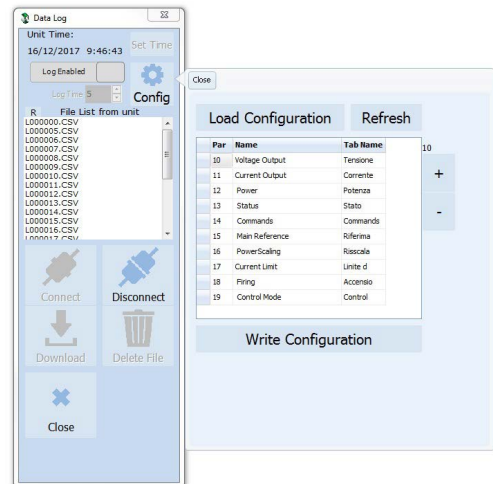

### 13.6.7 MSG view

Message view display the communication activity between the computer and the power controller.

#### PORT

**COM:** use this view to see when the COM port is accessed and its settings

**MODBUS:** Modbus communication protocol area

**READ Area:** use this view to see parameters being polled

**READ Area -> En Log:** enable a short read communication log activity

**READ Area -> En Detail:** if En Log enabled enable a detailed read communication log activity

**READ Area -> Only Error:** if En Log enabled enable a read communication log activity only if in error

**WRITE Area:** use this view to see what parameters and the value are send power control

**READ Area -> En Log:** enable a write communication log activity

**Log Msg:** use this view to see the "Data Log" protocol detail when Data Log windows is active

**Status:** view the status and settings of the COM port

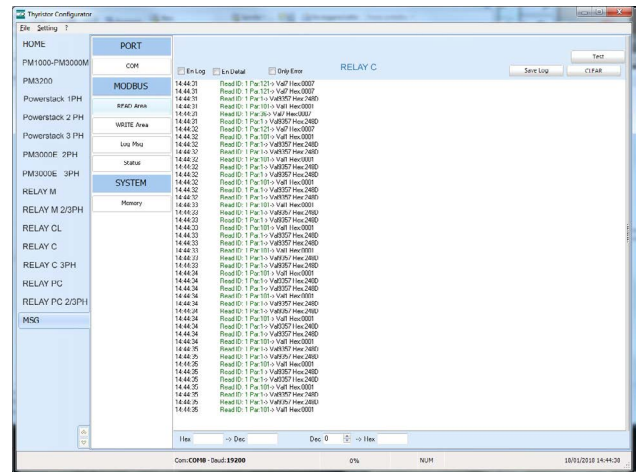

#### SYSTEM

**Memory:** view the memory usage of the Configurator program on the computer

### 13.6.8 Settings window

Use this window to choose user-settable options for the Configurator software.

**Language:**

**Available Languages:** choose the language used in the program



**NOTE!** to be active the language change, need close and open again the configuration software

**Serial Port:** Set the serial port parameter

**Test:** click to test for communication with a power controller via the selected port

**Port:** select the computer's COM port to use to communicate with power controllers

**Baud rate:** select Auto to allow the Configurator to set the baud rate for the COM port or deselect the option to set the baud rate yourself

**Options:** Set the configurator options

**List Options:** set whether or not parameter values are displayed in hexadecimal in simple view recipes

**Directory:** set the directories in which recipes and images are saved

**Disable Check Type:** set to allow communication with power controllers that are not precise matches for

the supported types. Used only for special version. Note that set is not memorized after software shutdown

**View:**

**Hide Tool Bar:** future use

**Hide Status Bar:** select to hide the status bar that appears at the bottom of the program window

**Show Instruments:** Hide or show the available instrument in the left side of main windows

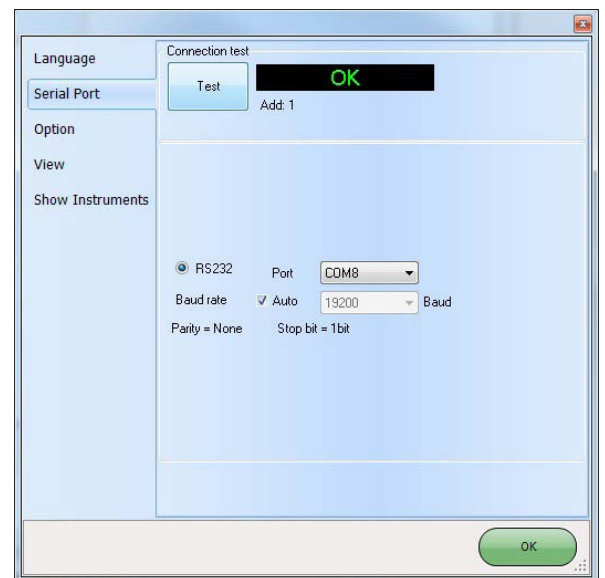

## 14. Firing Type

Choose a correct firing type allows to optimize the thyristor unit for the installed load.

The firing type has already configured in line with customer requirements that are defined in the Order Code.

The Order Code is written on the identification label.

However, if you wish to change the firing type you can use the software configurator or the Control Panel.



**Caution: this procedure must be performed only by qualified persons.**

### 14.1 Zero crossing

ZC firing mode is used with Logic Output from temperature controllers and the Thyristor operates like a contactor.

The Cycle time is performed by temperature controller. ZC minimizes interferences because the Thyristor unit switches ON-OFF at zero voltage.

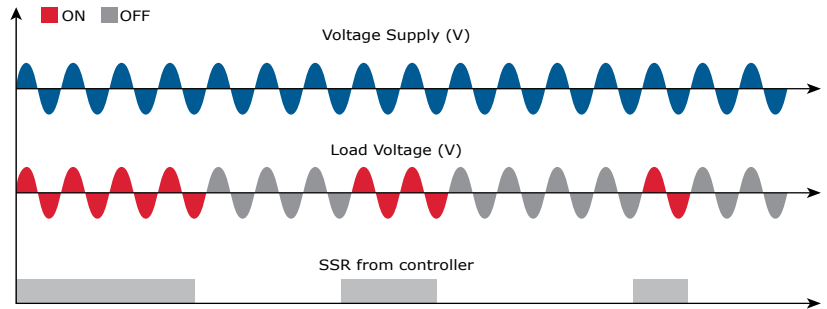

### 14.2 Burst firing

The Burst Firing is similar to the Single Cycle, but consecutive cycles ON are selectable between 1 and 255, with input signal equal at 50%.

Burst Firing is a method zero crossing that it reduces the electromagnetic interferences because the thyristor switches at zero voltage crossing. The example show the Burst Firing with Burst cycles=4.

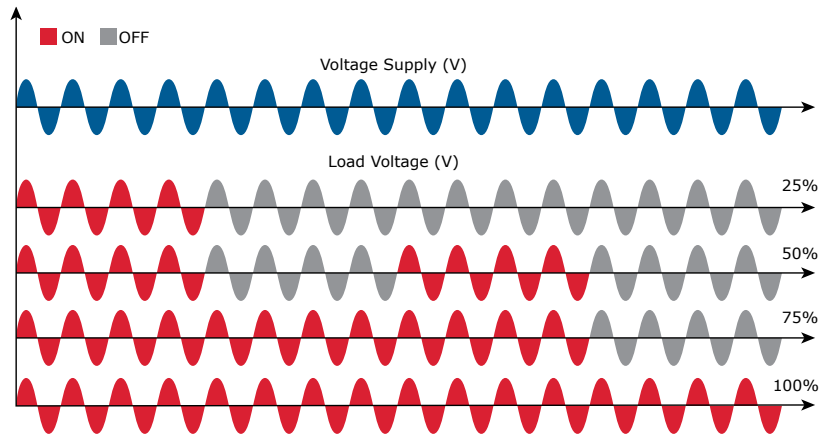



## 15. Control Mode (feed-back)

The Control Mode (feed-back) type has already configured in line with customer requirements that are defined in the Order Code. The Order Code is written on the identification label.

However, if you wish to change the Control Mode (feed-back) type you can use the software configurator or the Control Panel.



**Caution: this procedure must be performed only by qualified persons.**

The Control Mode (feed-back) type is defined by the parameter Control Mode (feed-back) in setup menu. If the configurable digital input has set like feed-back Selection, it's possible to change the select feed-back with the Voltage feed-back (V) simply activating the input.

It's possible to have:



**V2** = Square Voltage feed-back.

The input signal is proportional to the output square voltage. This means that input signal becomes a power demand. The power remains constant if the load impedance doesn't change.



**V** = Voltage feed-back.

The input signal is proportional to the output voltage. This means that input signal becomes a voltage demand. This control mode compensates the voltage fluctuation of the incoming line supply.



**I** = Current feed-back.

The input signal is proportional to the current output. This means that input signal becomes a current demand. This control mode maintain the current also if the load impedance changes.



**P(VxI)** = Power feed-back.

The input signal is proportional to the power output. This means that input signal becomes a power demand. The power remains constant also if voltage and load impedance change. This control mode is used with silicon carbide elements that change its resistive value with temperature and with age. In addition it compensates the voltage fluctuation of the incoming line supply.



**I2** = Square Current feed-back.

The input signal is proportional to the output square current. This kind of feed-back is suggested for cold resistance applications.



**None** = No feed-back Open Loop. The input is proportional to the firing angle ( $\alpha$ ).



**External** = External feed-back (0÷10V, 4÷20mA, 0÷20mA).

The input signal is proportional to an external signal. This means that input signal becomes a demand to maintain this signal always constant. This control mode is used for example with galvanic systems, where it's necessary to control the current value through the electrodes.

## 16. Supply the Electronic Board

The Relay C thyristor unit, to work, requires a voltage supply for the electronic boards. The Max consumption is 10VA.

The voltage supply for the electronic boards is configured in line with customer requirements that are defined in the Order Code. The Order Code is written on the identification label.



**Warning: Before connecting or disconnecting the unit check that power and control cables are isolated from voltage sources.**

Terminal M2-M4	Description
L1	Aux – Voltage Supply for electronic boards and synchronization (See order code for the Value)
-	Not Connected
L2/N	Aux – Voltage Supply for electronic boards and synchronization (See order code for the Value)

To change auxiliary supply voltage sold the correct link-jumper on Relay C board  
The type of mounted transformer depends of the chosen Voltage in the order code.

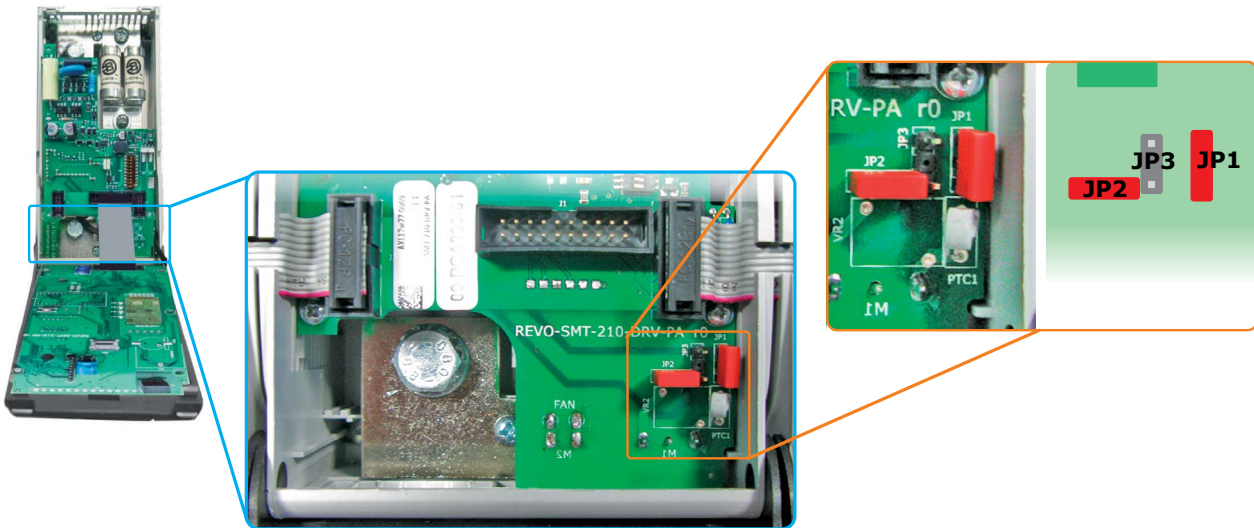

Order Code	As ordered		Change to	
	Jumper JP1 + JP2 are linked		Link only Jumper JP3	
	Transformer range	Line voltage	Transformer range	Line voltage
RC2_ _ _ _ 1	90:135V	100/120V	180:265V	200/208/220/230/240V
RC2_ _ _ _ 2	180:265V	200/208/220/230/240V	342:528V	380/400/415/440/480V
RC2_ _ _ _ 3	238:330V	277V	540:759V	600/690V
	Only Jumper 3 is linked		Link Jumper JP1 + JP2	
RC2_ _ _ _ 5	342:528V	380/400/415/440/480V	180:265V	200/208/220/230/240V
RC2_ _ _ _ 6	540:759V	600V	238:330V	277V
RC2_ _ _ _ 7	540:759V	690V	238:330V	277V

If the Auxiliary Voltage (written on the identification label) is different from Supply Voltage (to the load), use an external transformer with primary equal to load voltage and secondary equal to the Auxiliary Voltage.



**Attention! never link all the jumpers JP1+JP2+JP3 at the same time or JP3 + any other jumper, JP3 must be always alone, follow only the configuration shown.**

## 17. RS485 Serial Port

M3 Terminal	Description
11	RS485 A+
12	RS485 B-

The serial communication port RS485 is available on the Command Terminal. On this port may be done a network up to 127 Relay C.

## 18. Fieldbus Communication Option

Other serial communication port are available as option, see Communication Manual for details.

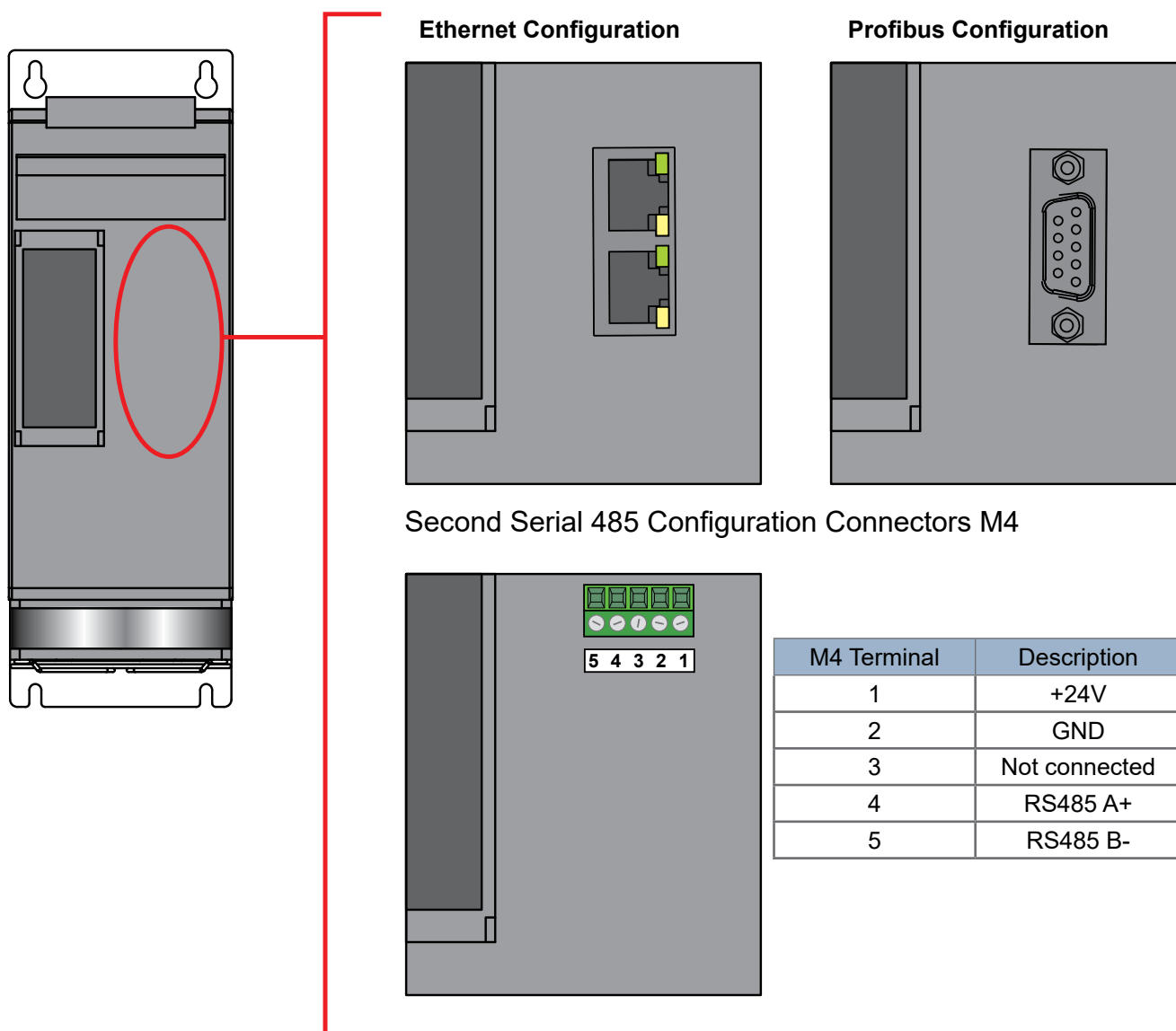

Second Serial 485 Configuration Connectors M4

M4 Terminal	Description
1	+24V
2	GND
3	Not connected
4	RS485 A+
5	RS485 B-

## 19. Internal Fuse

The thyristor unit have internal fuse extrarapid at low I<sup>2t</sup> for the thyristor protection of against the short-circuits. The Fuses must have I<sup>2t</sup> 20% less than thyristor's I<sup>2t</sup>. The warranty of thyristor is null if no proper fuses are used.

Type	Fuse Code Spare Part	Current (ARMS)	Vac	FUSE I2T value Suggested A2s (at500V)*	FUSE I2T value Suggested A2s (at660V)
060	20 559 20.160	160	660	10780	15400
090	20 559 20.160	160	660	10780	15400
120	20 559 20.180	180	660	14280	20400
150	20 559 20.200	200	660	17500	25000
180	20 559 20.250	250	660	30800	44000
210	20 559 20.315	315	660	53900	77000

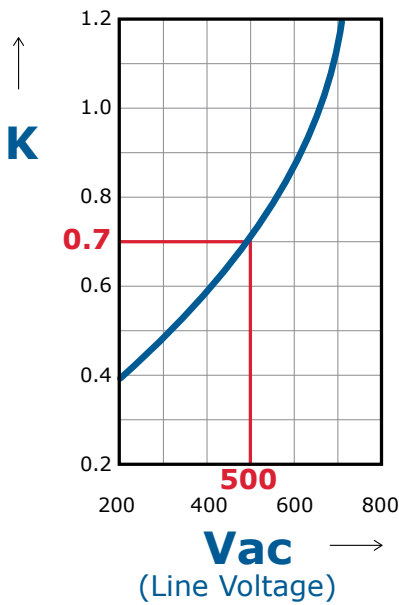

\*I<sup>2t</sup> are multiplied for K value in function of Vac at 500V K is equal to 0,7 (ex:15400 X 0,7 = 10780).  
At 660Vsc K is equal to 1.



**Caution:** High speed fuses are used only for the thyristor protection and can not be used to protect the installation.



**Caution:** The warranty of thyristor is null if no proper fuses are used. See tab.



**Warning:** When it is supply, the Thyristor unit is subject to dangerous voltage, don't open the Fuse-holder module and don't touch the electric equipments.

### 19.1 Fuses replacement

Open the cover and remove the screws, then replace it with the correct fuse, use the screws with a proper suggested torque indicated below:

Type	Screw	Torque Lb-in (N-m)
60-120A	M6	44.2 (5.0)
150-210A	M6	44.2 (5.0)

+

Screw	Torque Lb-in (N-m)
M5	31 (3.5)

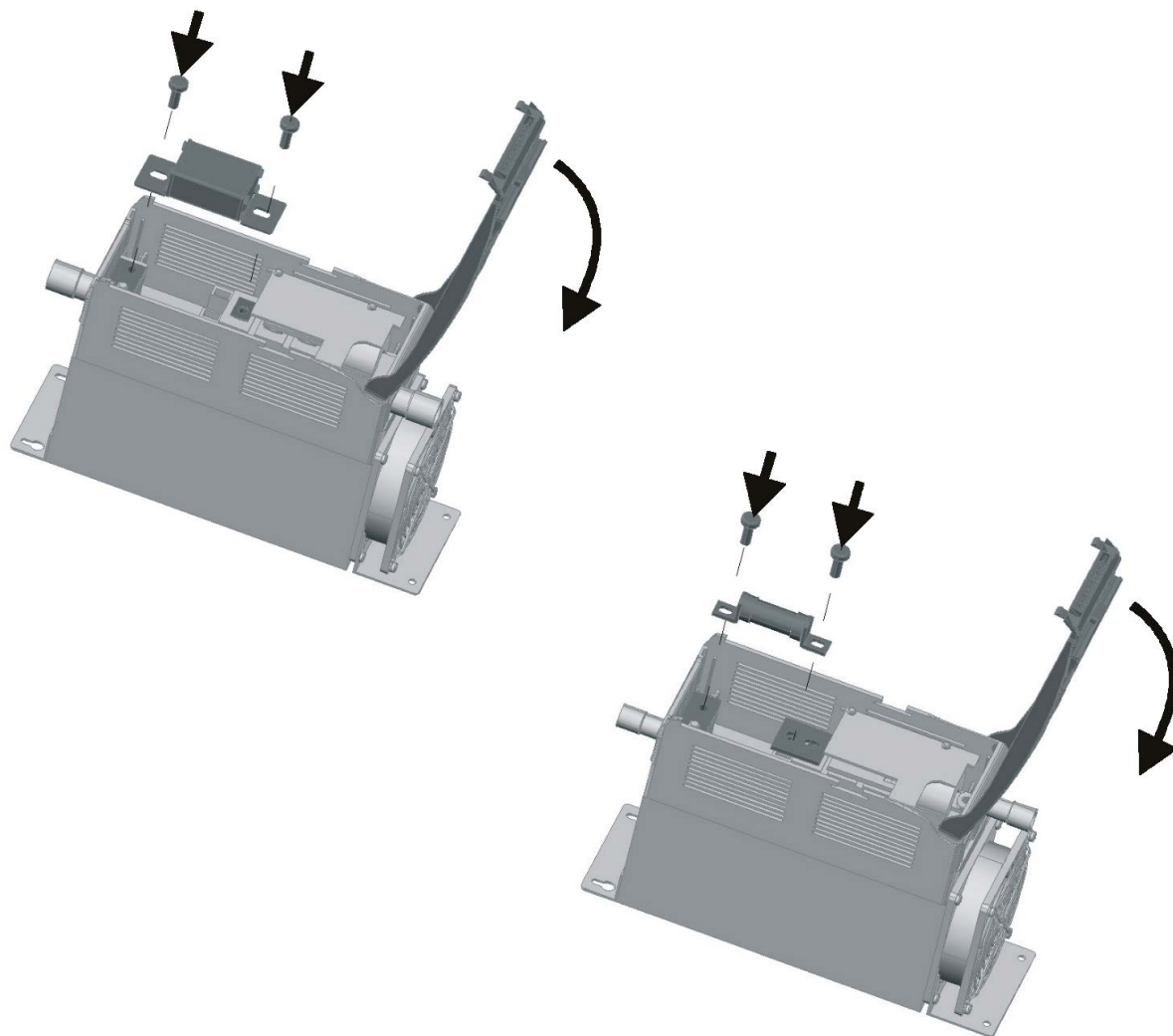

## Contact

### UK

**Email:** [enquiries@west-cs.com](mailto:enquiries@west-cs.com)

**Website:** [www.west-cs.co.uk](http://www.west-cs.co.uk)

**Telephone:** +44 (0)1273 606271

**Address:** The Hyde Business Park  
Brighton, East Sussex  
BN2 4JU  
United Kingdom

### Brazil

**Email:** [atendimento@ftvindtech.com](mailto:atendimento@ftvindtech.com)

**Website:** [www.west-cs.com.br](http://www.west-cs.com.br)

**Telephone:** 55 11 3616-0195 / 55 11 3616-0159

### China

**Email:** [china@west-cs.cn](mailto:china@west-cs.cn)

**Website:** [www.west-cs.cn](http://www.west-cs.cn)

**Telephone:** +86 400 666 1802

### France

**Email:** [fr@west-cs.com](mailto:fr@west-cs.com)

**Website:** [www.west-cs.fr](http://www.west-cs.fr)

**Telephone:** +33 171 84 1732

### Germany

**Email:** [de@west-cs.com](mailto:de@west-cs.com)

**Website:** [www.west-cs.de](http://www.west-cs.de)

**Telephone:** +49 561 505 1307

### USA

**Email:** [inquiries@west-cs.com](mailto:inquiries@west-cs.com)

**Website:** [www.west-cs.com](http://www.west-cs.com)

**Telephone:** +1 800 866 6659

West Control Solutions is part of the Fortive Corporation.  
Specifications are subject to change without notice, as a result  
of our continual development and improvement, E&OE.

**WEST**  
*Control Solutions*

UM-RC262-1-UK-1902