



# KS 94 Industrial & process controller

- New: Measurement value output and DAC**
- Simple, menu-guided operation with plain-text displays**
- Universal version for switching/continuous output**
- PROFIBUS-DP, INTERBUS or RS 485 interface**
- Programmer with search function and real-time clock**
- Display of customer-specific messages**
- Spray-water proof front with protection type IP 65**
- Interface ports at front and rear**

advanced line

## PROFILE

Safe, reliable control within close tolerances, and high plant availability are pre-requisites for economic production. Controllers with reliable and robust control algorithms are the basis for stable process conditions, also with varying operating parameters.

A self-tuning function ensures short start-up times. The "thinking" operator guidance system with standard symbols, plain-language texts plus software and hardware interlocks prevents operating errors and thus reduces down-times.

## DESCRIPTION

The KS 94 is configurable for ON/OFF control, PID-control and motorized valve control. The output function can be configured for  $\Delta/Y/Off$ , position control, split-range control, and numerous 3-point combinations of switching/continuous control.

Control modes are set-point, set-point/cascade, and programmer, each with the possibility of set-point offset. The effect of offset can be additive (e.g. reduced standby set-point) or as a factor (e.g.  $O_2$  correction or split load). Offset can be triggered by an external contact, whereby the value is defined via an analog signal or via an adjustable parameter.

## Additional control modes:

- Ratio control (stoichiometric combustion, mixing ratios, additives, batching, inline blending)
- Three-element control (e.g. level control in a steam boiler)
- Mean-value calculation from two process values.

Apart from a correcting function for the measurement signal, it is possible to scale, linearize or square-root every input and output signal. This enables the controller to be matched precisely to the application without any supplementary equipment.

For everyday practice, *feed-forward control* has proved very useful to line out disturbances, e.g. with steam-generating plants.

For applications where several controllers act on a single actuator, the *override control* function is recommended. If required, preset output limits can be used. This not only applies for continuous outputs, but also for switching and three-point stepping outputs (motor control).

## DAC ensures operational safety

Digital Actuator Control monitors the most important functions of the actuator and is able to detect problems long before they cause large control deviations. Typical disturbances are a blocked actuator, a defective motor or capacitor and all related problems with an actuator.

The DAC<sup>®</sup> function is available for three-point stepping and continuous controllers with position feedback.

## TECHNICAL DATA

### INPUTS

Inputs INP1, INP5 and INP6 are galvanically connected. For each input, a filter is selectable with a time constant of 0...999,9 s.

### UNIVERSAL INPUT INP1

Optional functions:

- Linearization with 7 segments
- Scaling
- Square-rooting
- Filter

Limiting frequency: 1 Hz

Measurement cycle: 200 ms

### Thermocouples

Type	Range	Error	Resolution
L	0...900°C	≤2K	0,05 K
J	0...900°C	≤2K	0,05 K
K	0...1350°C	≤2K	0,072 K
N	0...1300°C	≤2K	0,08 K
S	0...1760°C	≤3K	0,275 K
R	0...1760°C	≤3K	0,244 K
T	0...400°C	≤2K	0,056 K
W(C) <sup>1)</sup>	0...2300°C	≤2K	0,18 K
E	0...900°C	≤2K	0,038 K
B <sup>2)</sup>	(0)...400...1820°C	≤4K	0,3 K

<sup>1)</sup> W5Re / W26Re

<sup>2)</sup> Values apply above 400°C

Display in °C or °F.

With linearization (temperature-linear).

Input resistance: =1MΩ

### Break monitoring

Current through sensor: =1  $\mu$ A  
Action on break: configurable

### Reverse-polarity monitor

Triggered, if input signal 30K below span start.

### Cold-junction compensation

Built in (sensor leads or compensating leads must be taken up to the controller terminals).

Additional error: =0,5 K / 10 K at terminals

External CJ compensation selectable: 0...100  $^{\circ}$ C

### Resistance thermometer

Pt 100  $\Omega$  to DIN IEC 751, and temperature-difference 2 x Pt 100  $\Omega$

Range	Error	Resolution
-200...250,0 $^{\circ}$ C	$\leq$ 0,25K	0,024 K
-200...850,0 $^{\circ}$ C	$\leq$ 0,5K	0,05 K
2 x -200...250,0 $^{\circ}$ C	$\leq$ 0,5 K	0,024 K
2 x -200...850,0 $^{\circ}$ C	$\leq$ 1K	0,05 K

Display in  $^{\circ}$ C or  $^{\circ}$ F, decimal point selectable. With linearization (temperature-linear). Connection in three-wire technique, without lead adjustment. Two-wire connection with lead resistance adjustment.

Lead resistance:  $\leq$ 30  $\Omega$  per lead  
Sensor current:  $\leq$ 1 mA

### Input circuit monitor

Sensor and leads are monitored for break and short-circuit.

Output action: configurable

### Potentiometric transducer

Range	Error	Resolution
0...500 $\Omega$	$\leq$ 0,1 %	$\leq$ 0,02 $\Omega$

Resistance-linear

$R_{total} \leq$ 500  $\Omega$ , including 2 x  $R_{lead}$

Sensor current:  $\leq$ 1 mA

For transducers 500...1000  $\Omega$ , a parallel resistor must be fitted. This does not affect linearity. Matching and scaling is done with transducer connected.

### Input circuit monitor

Transducer and leads are monitored for break and short-circuit.

Output action: configurable

### Direct current

Range	Error	Resolution
0/4...20 mA	$\leq$ 0,1 %	$\leq$ 0,8 $\mu$ A

Input resistance: 50  $\Omega$

Measurement limits selectable in the range -999...9999.

Decimal point selectable.

### Input circuit monitor with 4...20 mA

Triggered, if input signal  $\leq$ 2 mA.

Output action configurable.

### Direct voltage

Range	Error	Resolution
0/2...10V	$\leq$ 0,1%	$\leq$ 0,4 mV

Input resistance: =100 k $\Omega$

Measurement limits selectable in the range -999...9999. Decimal point selectable.

### SIGNAL INPUT INP5

Differential amplifier input. Max. 2 inputs can be cascaded, if there is another galvanic connection between the instruments. If not, up to 6 inputs can be cascaded.

Optional functions:

Scaling / square-rooting / filter

### Direct voltage and direct current

Technical data as for INP1, but:

Limiting frequency: 0,25 Hz

Measurement cycle: 800 ms

### SIGNAL INPUT INP6

Optional functions:

Scaling / square-rooting / filter

### Potentiometric transducer

Resistance-linear:  $R_{total} =$ 1000  $\Omega$

including 2 x  $R_{lead}$

Sensor current: approx. 1 mA

Resolution: =0,04  $\Omega$ . Matching is done with transducer connected.

### Standard 0/4...20 mA signal

Data as for INP1.

### CONTROL INPUTS DI1, DI2

Opto-coupler

Nominal voltage: 24 VDC (external)

Current sink (IEC 1131 Type 1)

Logic "0" = -3...5 V

Logic "1" = 15...30 V

Current demand: approx. 5 mA

Fig. 1 Electrical connections

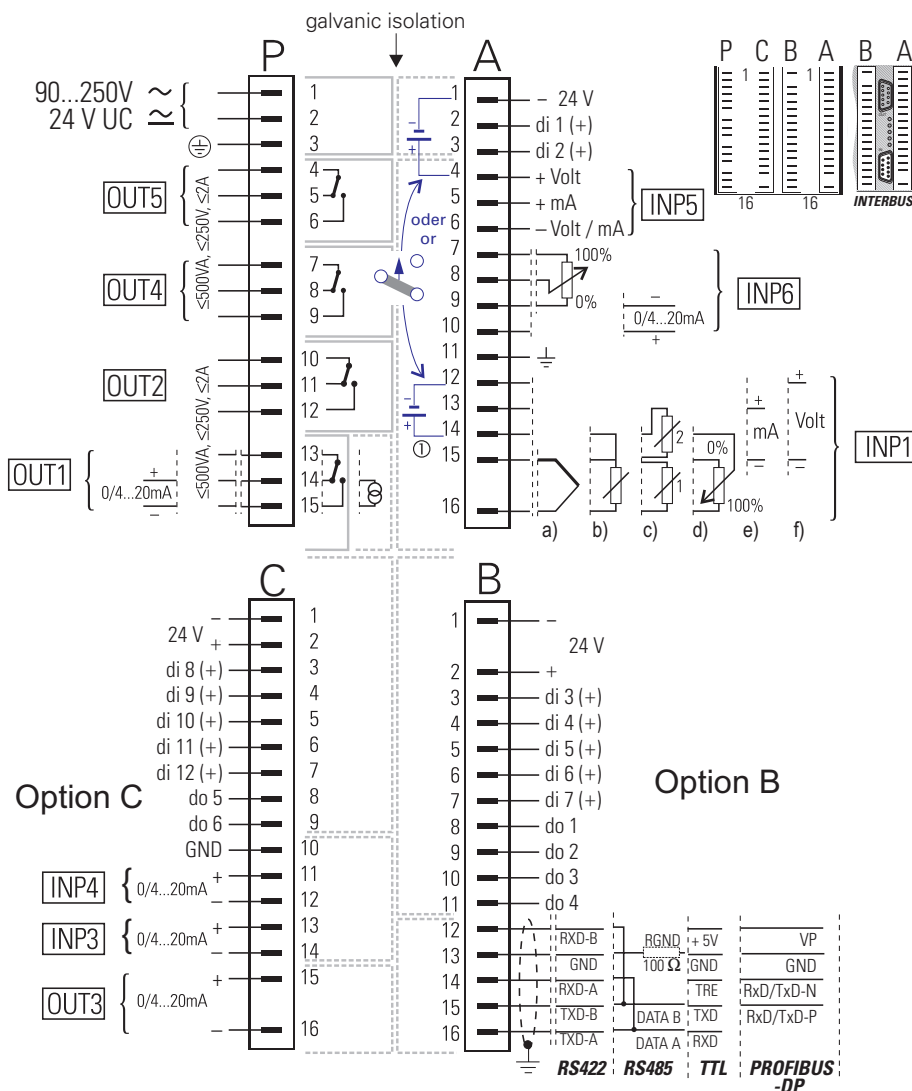

- ① only on versions with transmitter supply
- a) Thermocouples
- b) Pt 100
- c) 2 x Pt 100 ( $\Delta$ t)
- d) Potentiometric transducer
- e) 0/4...20 mA
- f) 0/2...10 V
- safety isolation
- - - functional isolation

The digital inputs are galvanically isolated from the other inputs/outputs, and from the mains supply.

### SIGNAL INPUTS INP3, INP4 (OPTIONAL)

Galvanically-isolated differential amplifier inputs. Optional functions: Scaling, square-rooting (linearization with 7 segments with INP4)

Direct current: Data as for INP1.

### CONTROL INPUTS DI8...DI1 (OPTIONAL)

Data as for di1 and di2, but galvanically connected with do5 and do6.

### CONTROL INPUTS DI3...DI7

Data as for di1 and di2, but galvanically connected with do1...do4.

### SURVEY OF INPUTS

Input	Used for
INP1	$x_1$ (process value)
INP3	$x_2$ (ratio, 3-element) $z$ (feed-forward input) $w_{sel}$ (min/max selection)
INP4	$w_{ext}$ (ext. set-point), $x_3$ (3-element) OVC (override control)
INP5	$w_{ext}$ (ext. set-point) $x_2$ (ratio, 3-element.) $dw_{ext}$ (ext. offset set-point)
INP6	$Y_p$ (position feedback) $dw_{ext}$ (ext. offset set-point) $w_{ext}$ (ext. set-point) $z$ (feed-forward input)
di1	$w/w_{ext}$ , $w/w_2$ , $w/dw_{ext}$ , auto/man, PI/P, auto/Y <sub>2</sub> , controller off, program start/reset + stop, disabling <sup>1)</sup>
di2	as for di1 + start of set-point tracking
di3	Local / remote
di4	Program start/stop
di5	Program reset
di6	Select program 1
di7	Select program 2
di8	Select parameter set 1
di9	Select parameter set 2
di10	OVC off, OVC + (open 3-point stepping contr.)
di11	OVC - (close 3-point stepping contr.) $w/dw_{ext}$
di12	Start set-point tracking, $w/w_2$

<sup>1)</sup> Disabling of auto/manual key, set-point adjustment, output switch-off, parameters, programmer operation.

### Built-in transmitter supply (optional)

Can be used to energize a two-wire transmitter or up to 4 opto-coupler inputs. Galvanically isolated  
Output: 17,5 VDC / 22 mA

### Factory setting

The transmitter supply is available at terminals A12 and A14, if INP1 is configured for **current** or **thermocouple** input. By means of internal switches, the voltage can be applied to terminals A1 and A4, where it is always available, irrespective of the input configuration.

### OUTPUTS

#### OUTPUTS OUT1, OUT2

Version-dependent, with relay output or continuous output/logic signal.

#### OUT1 and OUT2 with relay output

Relays 1 and 2 with potential-free switch-over contacts.

Contact rating:

Max. 500 VA, 250 V, 2 A at 48...62 Hz, resistive load

Min. 12 V, 10 mA AC/DC

#### Note:

If the relays operate external contactors, these must be fitted with RC snubber circuits to prevent excessive switch-off voltage peaks.

#### OUT1 with continuous output

Galvanically isolated from the inputs.

Freely scalable.

0/4...20 mA, configurable

Signal range: 0...approx. 22 mA

Resolution: =6  $\mu$ A (12 bits)

Load: 600  $\Omega$

Load effect: <0,1 %

Limiting frequency: approx. 1 Hz

#### OUT1 with logic signal

0/=20 mA with a load of =600  $\Omega$

0/>12 V with a load of >600  $\Omega$

#### RELAY OUTPUTS OUT4, OUT5

Data as for OUT1 and OUT2

#### CONTINUOUS OUTPUT OUT3 (OPTIONAL)

Galvanically isolated

#### Optional functions:

7-segment linearization or scaling.

#### Evaluation range:

Freely scalable with decimal point (zoom function), inverse or direct acting.

Other data as for OUT1.

#### LOGIC OUTPUTS DO5, DO6 (OPTIONAL)

Opto-coupler outputs, galvanically connected to inputs di8...di12, galvanically isolated from each other.

Grounded load:

common positive control voltage.

Output rating: 18...32 VDC; =100 mA

Internal voltage drop: =1 V with  $I_{max}$

Protective circuit: built-in against short circuit, overload, reversed polarity (free-wheel diode for relay loads).

#### LOGIC OUTPUTS DO1... DO4 (OPTIONAL)

Data as for do5 and do6, but galvanically connected with di4...di7.

### SURVEY OF OUTPUTS

Output	Used for
OUT1	Control outputs 1 & 2, Alarms 1, 2, 3, 4 Position feedback $Y_p$
<b>New function!</b>	Control deviation $x_{wv}$ Process values $x_1, x_2, x_3, x_{eff}$ Set-points $w, w_{eff}, w_{ext}, dw_{ext}, w_{prg}$
OUT2	Control outputs 1 & 2, Alarms 1, 2, 3, 4
OUT3	As for OUT1 except for alarms
OUT4	Alarms 1, 2, 3, 4, Control outputs 1 & 2 Progr. output 1, 2, 3 or 4 Progr. end
OUT5	Alarms 1, 2, 3, 4, Control outputs 1 & 2 Progr. output 1, 2, 3 or 4 Progr. end
do1	Programmer switching output 1
do2	Programmer switching output 2
do3	Programmer switching output 3
do4	Programmer switching output 4
do5	Auto/Man, Control output 1
do6	$w/w_{ext}$ , Control output 2

### ALARMS

#### Configurable alarms

- Sensor monitoring
- Sensor monitoring or input signal alarm
- Optional suppression during start-up or when changing the set-point.

#### Signals which can be monitored

- Process value  $x_{eff}, x_1, x_2, x_3$
- Control deviation  $x_{wv}$
- Set-points  $w_{eff}, w_{ext}, dw_{ext}, w_{sel}$
- Control output  $y$ , position-feedback signal  $y_p$ ,  $y$ -limiting (OVC)
- Input signals INP1...INP6
- Programmer times ( $t_{netr}, t_{gross}, t_{rest}$ )
- Bus status with PROFIBUS-DP and INTERBUS

#### Adjustment limits

Parameter	Limits
Lower limit LimL	-999...9999
Upper limit LimH	-999...9999
Switching difference XSd	1...999

Decimal point adjustable

## CONTROL BEHAVIOUR

### Effect of D-action

Either on process input  $x$  or on the control deviation  $x_w$ .

### Configurable controller types

- Standard controller
- Ratio controller
- Three-element controller
- Feed-forward control  $y_P$
- Mean value calculation

### Response on sensor break

Configurable as follows:

- neutral (outputs switched off)
- $y = y_{\min}$  (0%... $y_{\max}$ )
- $y = y_{\max}$  ( $y_{\min}$ ...100%)
- $y = y_2$  (fixed output value)
- $y = y_2$  (variable output value)

### Adjustment limits

Parameter	Symbol	Limits
Proportional band	$X_{p1}$	0,1...999,9%
Proportional band	$X_{p2}$	0,1...999,9%
Integral action	$T_n$	0...9999s
Derivative action	$T_v$	0...9999s
Duty cycle	$T_1$	0,4...999,9s
Duty cycle	$T_2$	0,4...999,9s
Switch point separ.	$X_{sh1}$	0...999,9%
Switch point separ.	$X_{sh2}$	0...999,9%
Switch point separ. <sup>2)</sup>	$X_{sh}$	2...999,9%
Motor actuator time	$T_m$	10...9999s
Shortest step	$T_{puls}$	0,1...999,9s
Switching diff.(sign.)	$X_{sd1}$	1...9999 <sup>1)</sup>
Switching differ.	$L_w$	-999...9999 <sup>1)</sup>
Switching diff. (auxil.)	$X_{sd2}$	1...9999 <sup>1)</sup>
2nd output	$Y_2$	-105...105%
Output limiting	$Y_{\min}$	-100(0)...100%
Output limiting	$Y_{\max}$	-100(0)...100%
Working point	$Y_0$	-100(0)...100%

1) Decimal point adjustable as for input range  $\times 1$  (INP1)

2) Applies for three-point stepping output

## SET-POINT FUNCTIONS

The following functions are configurable:

- Set-point control
- Set-point/cascade control
- Programmer
- Set-point with external offset ( $dw_{ext}$ )
- Set-point/cascade control with internal offset ( $dw$ )
- Set-point/cascade with external offset ( $dw_{ext}$ )
- Programmer with internal offset ( $dw$ )
- Programmer with external offset ( $dw_{ext}$ )
- Ratio control, with  $(x_1 + N_0)/x_2$  or  $(x_1 + N_0)/(x_1 + x_2)$  or  $(x_2 - x_1 + N_0)/x_2$
- Three-element, with  $x_1 + a(x_2 - x_3)$

Fig.2 Overall dimensions (in mm)

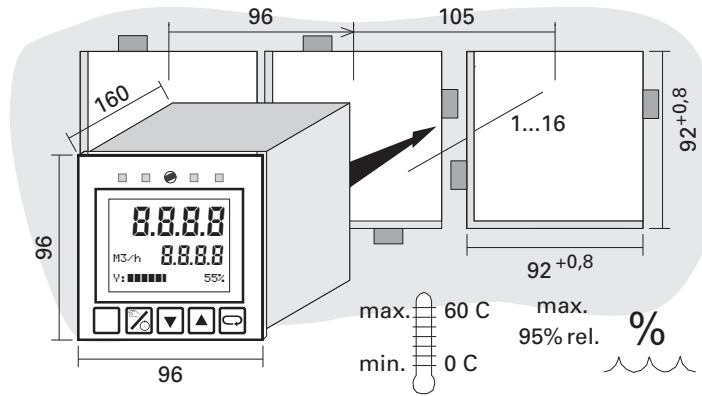

### Special functions

- Tracking  $w = w_{eff}$  when switching from external to internal
- Tracking  $w = x$  when switching from external to internal
- Mean value calculation with  $x_1 * (1-b) + x_2 * b$

### Adjustment limits

Parameter	Symbol	Limits
Set-point start	w0	-999...9999 <sup>1)</sup>
Set-point end	w100	-999...9999 <sup>1)</sup>
2nd set-point	W2	-999...9999 <sup>1)</sup>
Set-point offset	dW	-99,9...9999 <sup>1)</sup>
Positive SP gradient	Grw+	0,01...99,99 <sup>2)</sup>
Negative SP gradient	Grw-	0,01...99,99 <sup>2)</sup>
SP gradient for W2	Grw2	0,01...99,99 <sup>2)</sup>

1) Decimal point adjustable as for input range  $\times 1$  (INP1)

2) Adjusted "per minute"; disabled with "----"

## PROGRAMMER

3 programs with 20 segments each. 1 analog output and 4 switching outputs.

The analog output can be used as external set-point for the controller and/or be made available at OUT1 or OUT3.

### Without Option B (basic version)

- Run/Stop & Reset via common input di1 or di2.
- Alternatively, the programmer can be operated from the front panel or via the front interface (Run/Stop, Reset, Preset).
- Max. two switching outputs can be assigned to OUT4 and OUT5.

### With Option B

- Separate control inputs for:
  - Run/Stop (di4)
  - Reset (di5)
  - Program selection 1, 2 or 3 (di6, di7)
- Access to all 4 switching outputs via the opto-coupler outputs do1...do4 or via the relays OUT4, OUT5.

### Configurable programmer functions

#### Program selection

- via front panel or interface
- via control inputs (di6/di7)

#### Response after mains failure

- Continue program
- Switch-over to w
- Automatic search (basic setting)
- Automatic search; switch-over to internal set-point w if not successful
- Continue program at time mark of mains return (real time clock required)

#### Response at end of program

- Pause
- Reset ("Start" signal required)
- Continue with next program
- Next program and Reset ("Start" signal required)

### Timer functions

(only on version with RS 485 interface)

y/Y2	Switchover to fixed output
w/w2	Switchover to 2nd set-point W2
Controller off	Enabling/disabling the controller outputs
run	Start programmer

- Two outputs adjustable for single-shot event in minutes; hours; day; month; year.

## OPERATING FUNCTIONS

The following functions are configurable:

### Auto / Manual key

- Disabled
- Auto/Manual
- Automatic/y<sub>2</sub>
- Int/Ext (set-point) or internal/programmer

### System menu

- Start/stop self-tuning
- Program preset (option)
- Program reset (option)
- Program start/stop (option)
- Switch-over front/interface (option)
- Adjustment of real time clock (option)

### Extended operating level

- 12 parameters and signals can be copied into the extended operating level.

## DISPLAYS

Multi-function LC display with red backlighting

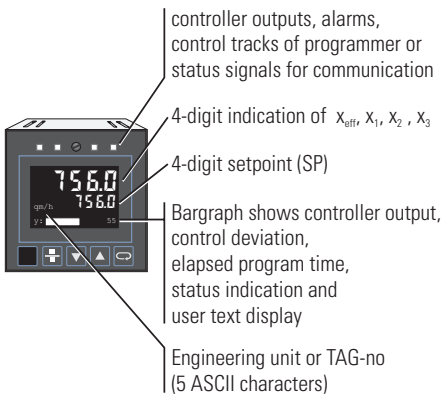
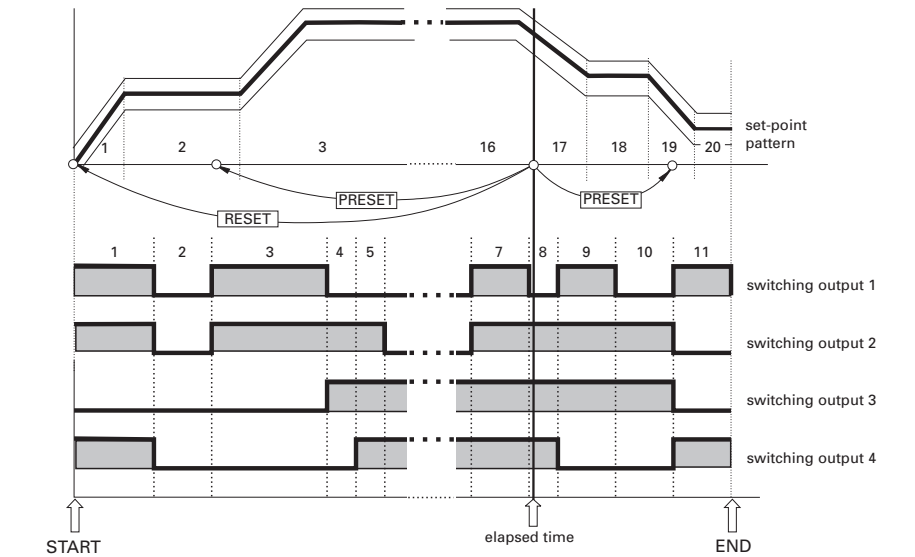

Fig. 3 Programmer with analog output and 4 control outputs



### User-defined texts

Up to 12 freely-definable texts of max. 16 characters each (7-bit ASCII) can be generated by means of the Engineering Tool or via the interface. The texts can be displayed temporarily instead of a permanent display, e.g. a bargraph.

Text	Condition	Digital input
1	Alarm 1	di1
2	Alarm 2	di2
3	Alarm 3	di3
4	Alarm 4	di4
5	Control output 1	di5
6	Control output 2	di6
7	Control output 3	di7
8	Control output 4	di8
9	Progr. output 1	di9
10	Progr. output 2	di10
11	Progr. output 3	di11
12	Bandwidth LC+/-	di12

## POWER SUPPLY

Depending on version:

### AC supply

90...260 VAC

Frequency: 48...62 Hz

Power consumption: approx. 10 VA

### Universal supply 24 V UC

24 VAC, 48...62 Hz / 24 VDC

Tolerance: +10...-15 %

Power consumption: appr. 10 VA (W)

### Behaviour after power failure

**Configuration, parameters, set-points:**  
Permanent data storage in an EEPROM.

**Programmer data (elapsed time):**  
temporary storage in capacitor-backed up RAM (>1 hour).

Configuration examples::

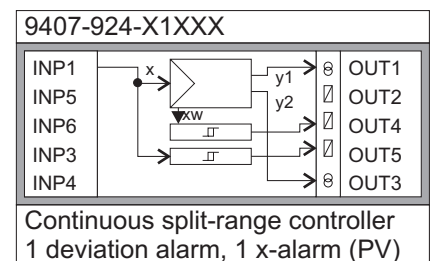
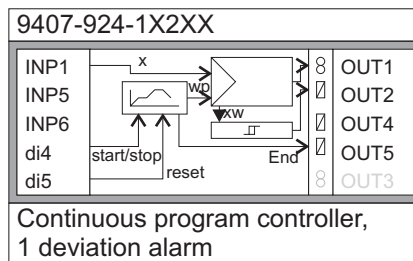
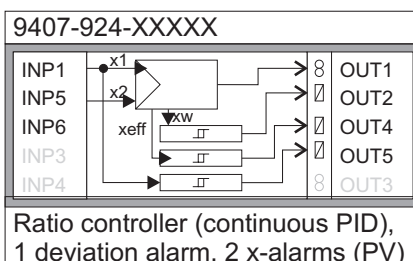
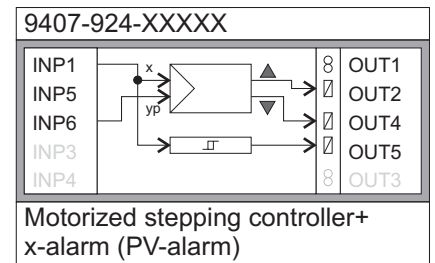
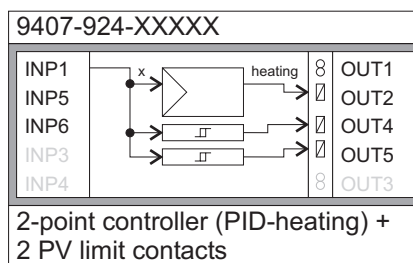
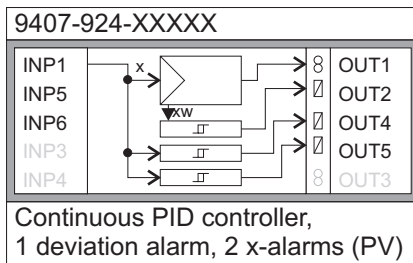

### *Real-time clock (optional)*

Buffer capacitor provides back-up for at least 2 days.

---

## **FRONT INTERFACE (STANDARD)**

Connection via PC adapter (see "Ordering Data for Accessory Equipment").

The Engineering Tool ET/KS 94 can be used for configuration, parameter setting, and operation of the KS 94.

---

## **BUS INTERFACE (OPTION B)**

### **TTL and RS 422/485**

Galvanically isolated, either TTL signals or RS 422/485

#### **Note:**

In order to convert TTL signals to RS 422/485, an interface module is required (see "Accessory Equipment").

Protocol: ISO 1745

Transmission speed:

2400 / 4800 / 9600 / 19.200 bits/s

Address range: 00...99

#### **Number of controllers per bus**

With RS 422/485: 32

With TTL signals: max. 32 interface modules on one bus. Above this value, the only limit is the address range (00...99).

### **PROFIBUS-DP INTERFACE**

➤ see data sheet 9499-737-37213

### **INTERBUS INTERFACE**

➤ see data sheet 9499-737-36213

---

## **ENVIRONMENTAL CONDITIONS**

### **Permissible temperatures**

For operation: 0...60°C

For specified accuracy: 0...55°C

Storage and transport: -20...60°C

### **Climatic category**

KUF to DIN 40 040

Relative humidity: 75% yearly average, no condensation

### **Shock and vibration**

#### **Vibration test Fc**

To DIN 68-2-6 (10...150 Hz)

Unit in operation: 1g or 0,075 mm

Unit not in operation: 2g or 0,15 mm

#### **Shock test Ea**

To DIN IEC 68-2-27 (15g, 11 ms)

---

## **ELECTROMAGNETIC COMPATIBILITY**

Complies with EN 50 081-2 and EN 50 082-2 for unrestricted use within rural and industrial areas.

### **Electrostatic discharge**

Test to EN 61 000-4-2

8 kV air discharge

4 kV contact discharge

### **High-frequency interference**

Test to EN 61 000-4-3

80...1000 MHz, 10 V/m

Effect: =1%

### **HF interference on leads**

Test to EN 61 000-4-6

0,15...80 MHz, 10 V

Effect: =1%

### **Low-frequency magnetic field**

Test to EN 61 000-4-8

No effect with 50 Hz, 30 A/m

### **Fast pulse trains (Burst)**

Test to EN 61 000-4-4

2 kV applied to leads for supply voltage and signal leads

### **High-energy single pulses (Surge)**

Test to EN 61 000-4-5

Test voltage applied to the following leads:

Supply leads:

1 kV symmetric, 2 kV asymmetric

Signal leads:

0,5 kV symmetric, 1 kV asymmetric

---

## **GENERAL**

### **Housing**

Plug-in module, inserted from front.

Material: Makrolon 9415 flame-retardant, self-extinguishing

Flammability class: UL 94 VO

### **Protection mode**

(to IEC 529, DIN 40 050)

Front: IP 65

Housing: IP 20

Terminals: IP 00

### **Safety tests**

According to EN 61 010-1 (VDE 0411-1)

Overvoltage category III

Contamination class 2

Working voltage range 300 VAC

Protection class I

### **CE marking**

The controller meets the European requirements regarding "Electromagnetic Compatibility" and "Low-voltage equipment" (see also "Safety tests")

### **Electrical connections**

Flat-pin connectors to DIN 46 244 for 1 x 6,3 mm or 2 x 2,8 mm

**Industrial & Process Controller KS 94**

### **Mounting method**

Panel mounting with two fixing clamps at top/bottom

### **Mounting position: Not critical**

**Weight: Max. 1,5 kg with all options**

### **Accessories**

3-language operating and safety instructions (GB/D/F)

2 fixing clamps

(Operating manual can be ordered separately, see "Ordering Data for Accessory Equipment")

---

## **ACCESSORY EQUIPMENT**

### **INTERFACE MODULE**

Up to 16 devices with TTL interface can be connected to the interface module. Connection is by means of the separately-ordered interface cable (1m long). Via the RS 422/485 interface (D-type connectors), the data are transmitted up to a distance of 1km.

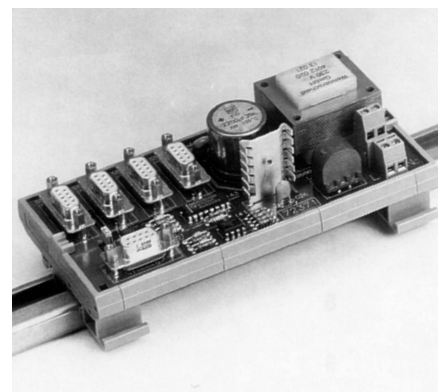

### **Supply voltage**

24 VAC, 230 VAC or 115 VAC, depending on version

Voltage tolerance: +10...-15%

Frequency: 48...62 Hz

Power consumption: approx. 5 VA

### **Electrical connections**

Screw terminals: 2,5 mm<sup>2</sup> solid or 1,5 mm<sup>2</sup> flexible

### **Mounting**

To standard DIN rail

### **Protection mode**

Type IP 00 (mounting in cabinet)

### **Permissible temperatures**

Operation: 0...60 °C

Storage and transport: -20...+60 °C

Relative humidity: <75 % yearly average, no condensation

**Weight: approx. 0,45 kg**

### **Dimensions**

158 x 78 x 60 mm (L x W x H)

### Engineering Tool ET/KS 94

This PC-based program is used for configuration and parameter adjustment (commissioning) of the controllers KS 92 and KS 94. Furthermore, all settings are stored, and can be printed out, if required.

Together with the software package SIM/94 (see below) a trend display of the true process data is possible.

Software platform:

Windows 3.11 or Windows 95 must be installed and operable.

Hardware platform:

For connection to the controller, a PC adapter is required (see "Ordering Data for Accessory Equipment").

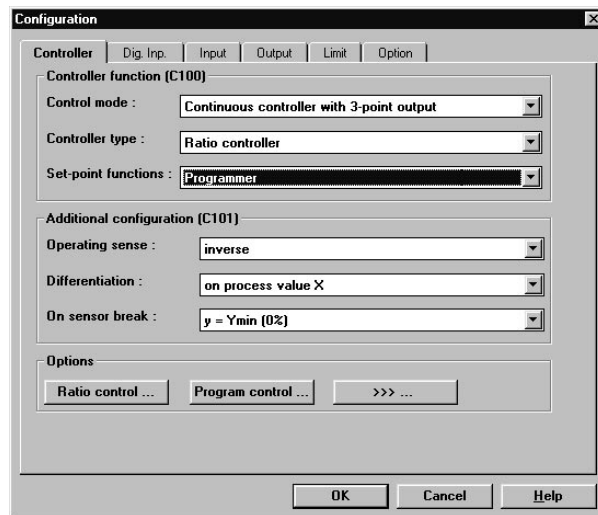

### Controller simulation SIM/94

This PC-based program is used to test the settings of industrial controllers KS 92 and KS 94 in a simulated control loop. The program enables you to test the controller settings and also to examine the interaction between a controller and the process without disturbing the real plant.

During simulation, the controller's front keys are operated via a mouse or the Engineering Tool.

The built-in trend graphics enable you to monitor the process value, set-point, and output value. The trend display can also be used to visualize the process response in the Engineering Tool.

Recorded data can be exported into external data processing programs such as spreadsheets, etc.

Software platform:

Windows 3.11 or Windows 95 must be installed and operable.

Updates and demonstration software available via:

[www.pma-online.de](http://www.pma-online.de)

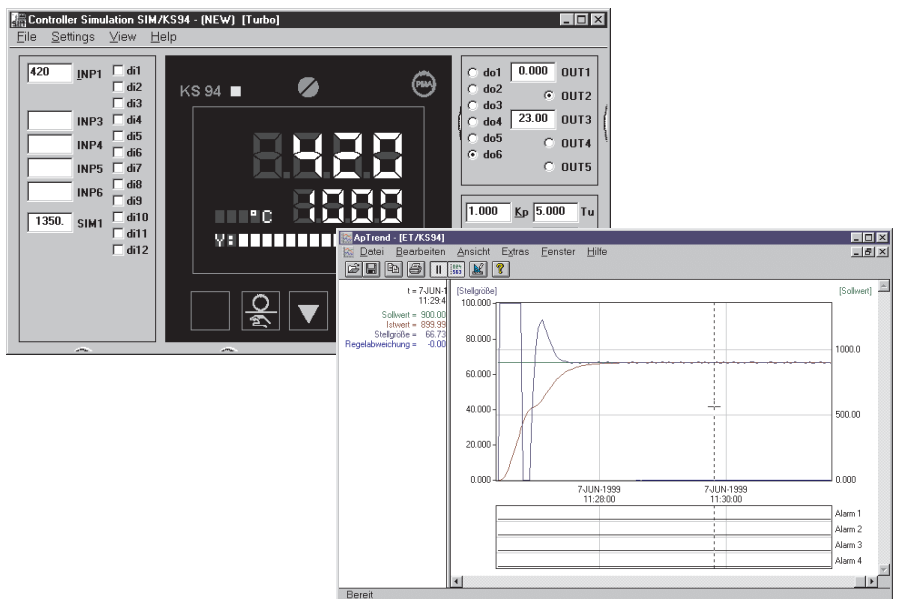

## ORDERING DATA FOR ACCESSORY EQUIPMENT

Description		Order no.
Interface cable, length 1 m		9404 407 50011
Interface module, 230 VAC supply		9404 429 98001
Interface module, 115 VAC supply		9404 429 98011
Interface module, 24 VAC supply		9404 429 98021
PC adapter, for connecting the Engineering Tool		9407 998 00001
Engineering Tool ET/KS 94	English/German	9407 999 01801
Engineering Tool ET/KS 94, 10x license	English/German	9407 999 02801
Controller simulation SIM/KS 94	English/German	9407 999 03801
Controller simulation SIM/KS 94, 10x license	English/German	9407 999 03901
MSI Server - 32 Bit DDE-Server	English/German	9407 999 07101
Converter RS 232 to RS 422 (incl. RS 232 cable, 10m cable RS422)		9407 998 00041
Engineering Set for Profibus-DP	German	9407 999 05201
Engineering Set for Profibus-DP	English	9407 999 05101
PROFIBUS adapter, screw terminal		9407 998 00021
PROFIBUS adapter, Sub-D connector		9407 998 00031
Operating instructions	German	9499 040 44218
	English	9499 040 44211
	French	9499 040 44232
Manual	German	9499 040 44818
	English	9499 040 44811
	French	9499 040 44832
Operating notes for ISO 1745 interface	German	9499 040 45018
	English	9499 040 45011

## ORDERING INFORMATION

		9	4	0	9				1
		↑			↑	↑	↑	↑	
		7			8				
		Flat pin connectors							
		Screw terminal connectors							
<b>BASIC VERSION</b>	<b>KS 94</b>				2				
	<b>KS 94 with transmitter power supply</b>				3				
<b>POWER SUPPLY AND PROCESS OUTPUTS</b>	90...250V AC 4 relays				3				
	90...250V AC 3 relays + current/logic output				4				
	24V UC 4 relays				7				
	24V UC 3 relays + current/logic output				8				
									Universal version continuous/switching
									Universal version continuous/switching
<b>OPTION B SERIAL INTERFACE</b>	no interface				0				
	TTL-interface + di/do				1				
	RS422 + di/do + clock				2				
	PROFIBUS-DP + di/do				3				
					4				
<b>OPTION C EXTENSIONS</b>	no extension				0				
	INP3, INP4, OUT3, di/do				1				
	OUT3				5				
<b>EXTRA FUNCTIONS</b>	no additional functions				0				
	measurement correction				1				
	measurement correction + programmer				2				
<b>PRE-CONFIGURATION</b>	Standard configuration				0				
	2-point controller for heating				1				
	3-point stepping controller for motorized valves				2				
	continuous controller (current output required)				3				
	3-point controller (Logic/relays, current output required)				4				
	3-point stepping controller for 3-element control (INP3, INP4 required)				5				
	continuous controller for 3-element control (INP3, INP4 required)				6				
	configuration to specification				9				

DAC® is a registered trademark of  
Regelungstechnik Kornwestheim GmbH.



**Germany**  
PMA  
Prozeß- und Maschinen-Automation GmbH  
Miramstraße 87, D-34123 Kassel  
Tel.: +49 561 505 - 1403  
Fax: +49 561 505 - 1661  
E-mail: export@pma-online.de  
Internet: http://www.pma-online.de

**Your local distributor**